

USER GUIDE

MAN0149 rev 6

# FBXi-X256

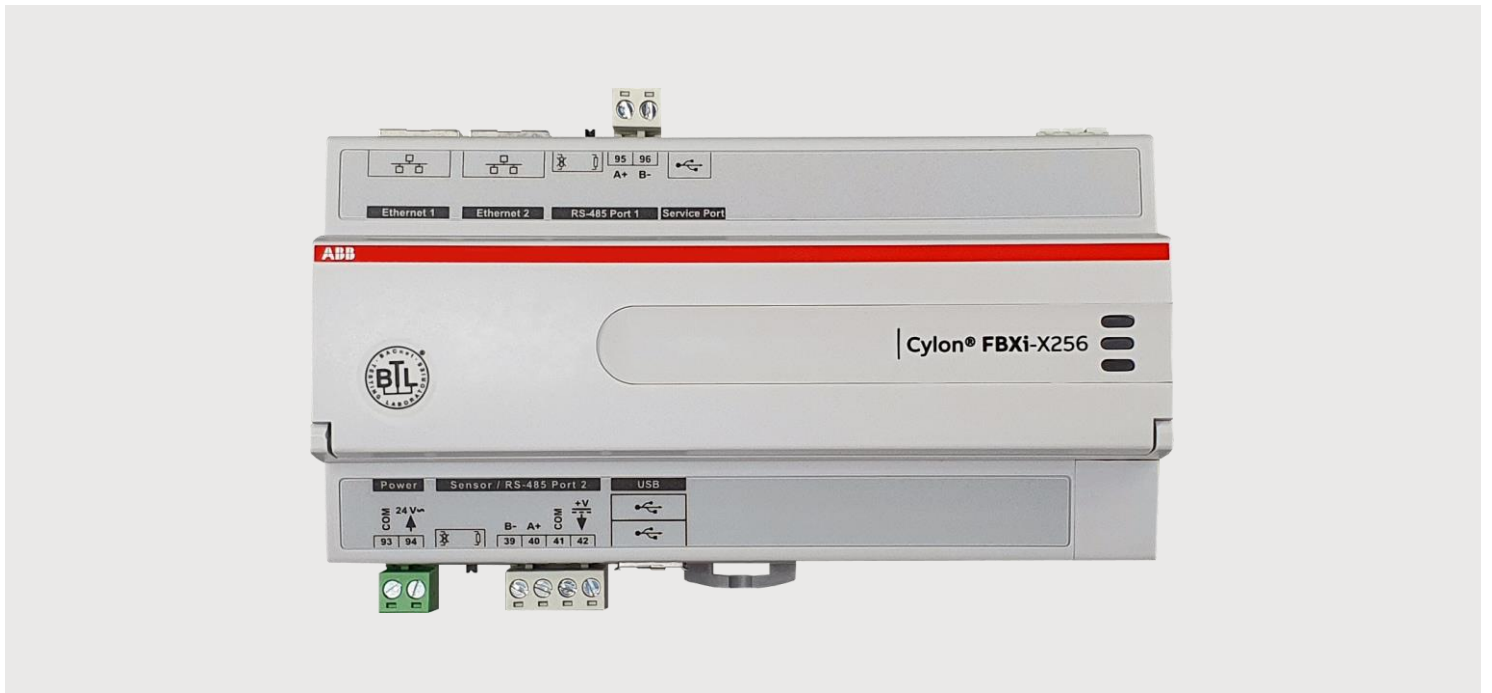

### Style conventions used in this document:

**UI Text:** Text that represents elements of the UI such as button names, menu options etc. is presented with a grey background and border, in Tahoma font which is traditionally used in Windows UIs. For example:

Ok

**Standard Terms (Jargon):** Text that is not English Language but instead refers to industry standard concepts such as Strategy, BACnet, or Analog Input is represents in slightly condensed font. For example:

BACnet

**Code:** Text that represents File paths, Code snippets or text file configuration settings is presented in fixed-width font, with a grey background and border. For example:

```
$config_file = c:\CYLON\settings\config.txt
```

**Parameter values:** Text that represents values to be entered into UI fields or displayed in dialogs is represented in fixed-width font with a shaded background. For example

10°C

**Product Names:** Text that represents a product name is represented in bold colored text. For example

INTEGRA™

**Company Brand names:** Brands that are not product names are represented by bold slightly compressed text:

ABB Active Energy

**PC Keyboard keys:** Text representing an instruction to press a particular key on the keyboard is enclosed in square brackets and in bold font. For example:

[Ctrl]+[1]

# table of contents

1	THE FBXi-X256	
	Introduction .....	6
	Application.....	6
2	IP NETWORKING	
	What is IP? .....	7
	Physical Layer (Layer 1) .....	7
	DataLink Layer (Layer 2).....	7
	Network Layer (Layer 3).....	7
	Transport Layer (Layer 4).....	7
	Session Layer (Layer 5).....	7
	Presentation Layer (Layer 6).....	7
	Applications Layer (Layer 7) .....	7
	IP Addressing .....	8
	DHCP (Dynamic Host Configuration Protocol) .....	8
	Subnetwork (Subnet).....	8
	Default gateway.....	9
	Port Numbers.....	10
	Uplink/WAN and Segmentation .....	11
	Network Address Translation (NAT).....	12
	Domain Name System (DNS).....	12
3	BACNET NETWORKING	
	What is BACnet? .....	13
	BACnet object types.....	14
	BACnet services.....	14
	BACnet's Client / Server nature.....	15
	Network Types.....	15
	PIC Statement.....	15
	BACnet Topology .....	16
	BACnet IP .....	17
	BACnet IP Broadcast Management Device (BBMD) .....	17
	BACnet MS/TP .....	18
	Token Passing .....	18
	Addressing .....	18
	Baud Rates .....	19
	Network Optimization .....	19
	BACnet MS/TP Device Loading.....	19
	Read Property Multiple.....	19
	BACnet Priority Array.....	20
4	FBXi WEB UI	
	Summary Dashboard .....	21
	BACnet Menu.....	22
	Device .....	22
	Router Networks .....	22

## table of contents

Time Sync .....	23
BBMD / NAT .....	24
<b>IP Network Menu .....</b>	<b>25</b>
Configuration .....	25
TCP/UDP Ports .....	26
Edit SSL Cert / Sign SSL Cert .....	27
<b>RS-485 Port Menu .....</b>	<b>28</b>
Configuration .....	28
Status .....	29
<b>Platform Menu .....</b>	<b>30</b>
Status report .....	30
Firmware Upgrade utility .....	30
Backup/Restore utility .....	31
Set Time and Date .....	32
Restart utility .....	33
<b>Diagnostics Menu .....</b>	<b>34</b>
Processes .....	34
Debug Level .....	35
System logs.....	36
Open-source acknowledgment notices .....	37
<b>5 INSTALLATION</b>	
<b>Apply power to the FBXi-X256 .....</b>	<b>38</b>
<b>Connect the FBXi to an IP network .....</b>	<b>38</b>
The FBXi Integrated Ethernet Switch.....	39
Configuring the IP connection .....	39
<b>Configure the FBXi-X256 for BACnet® communications .....</b>	<b>47</b>
<b>Connect the FBXi to BACnet MS/TP .....</b>	<b>49</b>
Terminate the MS/TP network.....	49
Attach RS-485 communication wires to the MS/TP Subnet port.....	49
<b>Connect the FBXi-X256 to FLX units.....</b>	<b>50</b>
Set the FLX address .....	50
Join or terminate the FLX bus .....	51
(If required) Set up FLX bus extension .....	51
<b>Add the Controller to the CXpro<sup>HD</sup> Site .....</b>	<b>54</b>
Set Controller Date and Time .....	54
Set up the FBXi and connected FLX modules in a Site in CXpro <sup>HD</sup> .....	55
(if required) Configure a Modbus Connection .....	59
Set I/O to a known Safe Mode .....	66
Set up the Controller Strategy .....	66
Accessing Modbus points in the Strategy.....	68
<b>6 FBXi OPERATION</b>	
<b>Physical Layout .....</b>	<b>70</b>
FBXi Indicator LED Signals .....	71
<b>Inputs and Outputs – FLX modules .....</b>	<b>72</b>
Input modes .....	72
Output modes.....	75
<b>Auxiliary Power outputs .....</b>	<b>76</b>
<b>Using a Keypad with the FBXi .....</b>	<b>77</b>
<b>Restarting, Resetting and upgrading the FBXi .....</b>	<b>78</b>

## table of contents

Resetting the WebUI login.....	78
Full factory reset.....	78
Upgrade Firmware from USB.....	78
Restarting the controller without power cycling.....	78

# 1 The FBXi-X256

## INTRODUCTION

The **FBXi Series** is a freely programmable range of BACnet® Controllers with native BACnet/IP communications support. The controllers are BTL listed (pending) BACnet Building Controller (B-BC) and are ideally suited for a wide range of applications for intelligent control of HVAC equipment, and electrical systems including lighting control and metering applications. The **FBXi-X256** controller supports multi-protocol communications simultaneously including BACnet/IP, BACnet MS/TP, Modbus® TCP and Modbus RTU.

Part of Cylon's **FLXeon Line** of BACnet field controllers, the **FBXi-X256** controller features support for up to sixteen **FLX (Field Level eXpansion)** series extension modules providing up to 256 points of control, and a dedicated input for Cylon's **CBT-STAT** or **UCU Room Display** intelligent room sensors. **FLX I/O** expansion modules are available in a variety of options to allow maximum flexibility in achieving the required point configuration.

## APPLICATION

The **FBXi Series** is designed for a wide range of energy management applications for intelligent control of:

- HVAC equipment such as Central Plant, Boilers, Chillers, Cooling Towers, Pump Systems, Air Handling Units (Constant Volume, Variable Air Volume and Multi-zone), and Rooftop Units,
- Electrical systems such as lighting control, variable frequency drives and metering.

The **FBXi Series** can be used as an integration platform and natively supports the routing of either BACnet MS/TP to BACnet/IP or Modbus RTU to Modbus TCP without the need for gateways or additional hardware.

The controller accommodates available pre-engineered strategies or can be tailored to custom applications using **CXpro<sup>HD</sup>** programming software

## 2 IP Networking

### WHAT IS IP?

IP (Internet Protocol) is an agreed standard that defines how devices communicate over the Internet or other Internet-like Ethernet network.

IP is part of a 7-layer architecture consisting of

- Physical Layer (Layer 1)
- DataLink Layer (Layer 2)
- Network Layer (Layer 3)
- Transport Layer (Layer 4)
- Session Layer (Layer 5)
- Presentation Layer (Layer 6)
- Applications Layer (Layer 7)

### PHYSICAL LAYER (LAYER 1)

This refers to the electrical impulses (or light signal or radio signals) carried on the cable (or fiber, air or other physical medium). For IP, the physical layer is usually Ethernet.

### DATALINK LAYER (LAYER 2)

This is where data packets are translated to and from bits, which can be transferred on the Physical Layer

### NETWORK LAYER (LAYER 3)

Layer 3 provides switching and routing to create paths for data to be transmitted from node to node within the network. This is the layer that gives IP its name.

### TRANSPORT LAYER (LAYER 4)

This layer is responsible for end-to-end error recovery and flow control, enabling transparent transfer of data between hosts.

### SESSION LAYER (LAYER 5)

The Session layer manages exchanges (conversations) between the “applications” on each host.

### PRESENTATION LAYER (LAYER 6)

This layer translates between application and network formats, so that communication independent of data representation such as ASCII, GIF, JPEG etc.

### APPLICATIONS LAYER (LAYER 7)

Everything at layer 7 is application-specific, such as Telnet, FTP, WWW browsers, HTTP etc.

## IP ADDRESSING

Each device has at least one IP address, which uniquely identifies it from all other devices on the network.

There are several forms of IP addresses, but the most commonly used is IPv4, which consists of 4 numbers (between 0 and 255) separated by dots e.g. 192.168.222.51

### DHCP (DYNAMIC HOST CONFIGURATION PROTOCOL)

The address can be set manually on the device itself, or else the device can be assigned one by a master controller on the network. This master controller is known as the Dynamic Host Configuration Protocol (DHCP) server.

To use an IP address, a device must know several pieces of data, including the IPv4 address that the device will use, the IP address of the Domain Name Server (DNS) where the device can find IP addresses of other devices, and the IP address of the Default Gateway device through which communications are routed.

Using DHCP means that all these pieces of information are set automatically avoiding the need for specialist knowledge of IP networking. If DHCP is available on your network is the most convenient way to configure your devices.

#### DHCP reservation

A DHCP server can be configured to always assign a particular IP address to a specific device. This is called a DHCP reservation and enables a user to access a device by IP address even if the device power-cycles and makes a new DHCP request.

### SUBNETWORK (SUBNET)

A subnet is a logical division of a network – that is while it might be physically connected to other subnets, communications traffic from one subnet can be kept separate from comms origination on other subnets.

A group of the most significant bits of the IPv4 address (the numbers at the start of the address) specifies the address of a network or subnetwork. This is called the Network Prefix. The remainder specifies the host – the address unique to the specific device.

For example:

- on the 192.168 subnet, an IP address of 192.168.2.54 refers to device 2.54.
- On the 55.231.77 subnet, IP address 55.231.77.3 refers to device 3

The specific parts of the address that are in each portion is defined by the device's 'Subnet Mask'. This can be expressed as a "bitmask" that is applied by a bitwise AND operation – e.g. 255.255.0.0 means that only the last 2 segments of the address apply to the local subnet.

For example,

- if the address 192.168.2.54 has a subnet mask "255.255.0.0", that means that 192.168 is the subnet address, and 2.54 is the device address.
- if the address 55.231.77.3 has a subnet mask "255.255.255.0", that means that 55.231.77 is the subnet address, and 3 is the device address.

The network can also be identified by a decimal number following the first IP address on the network – e.g. 55.231.77.0/24. This is called Classless Inter-Domain Routing (CIDR) notation. The decimal number represents the number of bits allocated for the Network Prefix.

Each segment of an IP address represents 8 bits,

i.e. 192.168.2.54 could also be written 11000000 . 10101000 . 00000010 . 00110110



In CIDR notation, /16 means that 16 of these bits represents the subnet, and the remainder specifies the host:

CIDR	192.168.2.54/16																																	
IP Address decimal	192	.	168	.	2	.	54																											
IP Address Binary	1	1	0	0	0	0	0	.	1	0	1	0	1	0	0	0	.	0	0	0	0	0	0	1	0	.	0	0	1	1	0	1	1	0
																																		
Equivalent subnet mask	255	.	255	.	0	.	0																											

CIDR	55.231.77.3/24																																		
IP Address decimal	55	.	231	.	77	.	3																												
IP Address Binary	0	0	1	1	0	1	1	1	.	1	1	1	0	0	1	1	1	.	0	1	0	0	1	1	0	1	.	0	0	0	0	0	0	1	1
																																			
Equivalent subnet mask	255	.	255	.	255	.	0																												

### DEFAULT GATEWAY

Devices on the same subnet can address IP packets to each other without using a router device.

To communicate with devices on another subnetwork, the traffic must be routed through a router device’s WAN port. When a device needs to communicate with an IP address that is not on the same network, it sends the packet to the Default Gateway, which is usually the subnet’s Router.

**Note:** Some BACnet services use “broadcasts” (e.g. “Who-Is”). On a LAN with standard routers, these broadcasts are “blocked”. As a result, BACnet broadcasts are limited to the IP Subnet of the BACnet device. With a BACnet/IP network of 2 or more IP subnets, a device that can act as a BACnet/IP Broadcast Management Device (BBMD) must be used.

## PORT NUMBERS

A “Port” on an IP device is a concept that allows traffic to be mapped within a device’s address to a specific process running in that device. A Port number forms part of a data packet’s IP address, but is often set by convention, depending on the protocol that the packet uses. For example, HTTP traffic by convention uses port 80. If no port is specified in the IP address for HTTP traffic, port 80 will be assumed. If a port is specified (e.g. port 8080 as in the address 192.168.100.33:8080), the specified port will be used instead. This allows the device to communicate on multiple protocols at the same time.

Some of the services associated with port numbers include:

Service	Protocol	Default Port Number
SMTP	TCP	25
DNS	TCP, UDP	53
DHCP	UDP	67
HTTP	TCP	80
HTTPS	TCP	443
BACnet/IP	UDP	47808

Some of the port numbers recognized by FBXi are shown below. These can be changed in the controllers Web UI at [IP Network > TCP/UDP Ports](#)

Device name: **FBXi 40002 192.168.5.213**

**IP Network TCP/UDP Ports**

IP Network TCP and UDP ports are ports open to the outside world. HTTPS/HTTP are used for this web configuration. HTTPS is always enabled, though the port can be changed if required. HTTP is disabled by default. The BACnet ports are needed if the controller must communicate with other BACnet controllers over IP.

Protocol	Enabled	Number
https	<input checked="" type="checkbox"/>	443
http	<input checked="" type="checkbox"/>	80
BACnet	<input checked="" type="checkbox"/>	47808
BACnet NAT	<input checked="" type="checkbox"/>	47809

## UPLINK/WAN AND SEGMENTATION

Physically splitting a network into different function groups is known as “Network segmentation”. This is done to improve performance (by reducing the amount of traffic on each segment) and to improve security. It is achieved by connecting Routers together by their “WAN” or “UPLINK” ports.

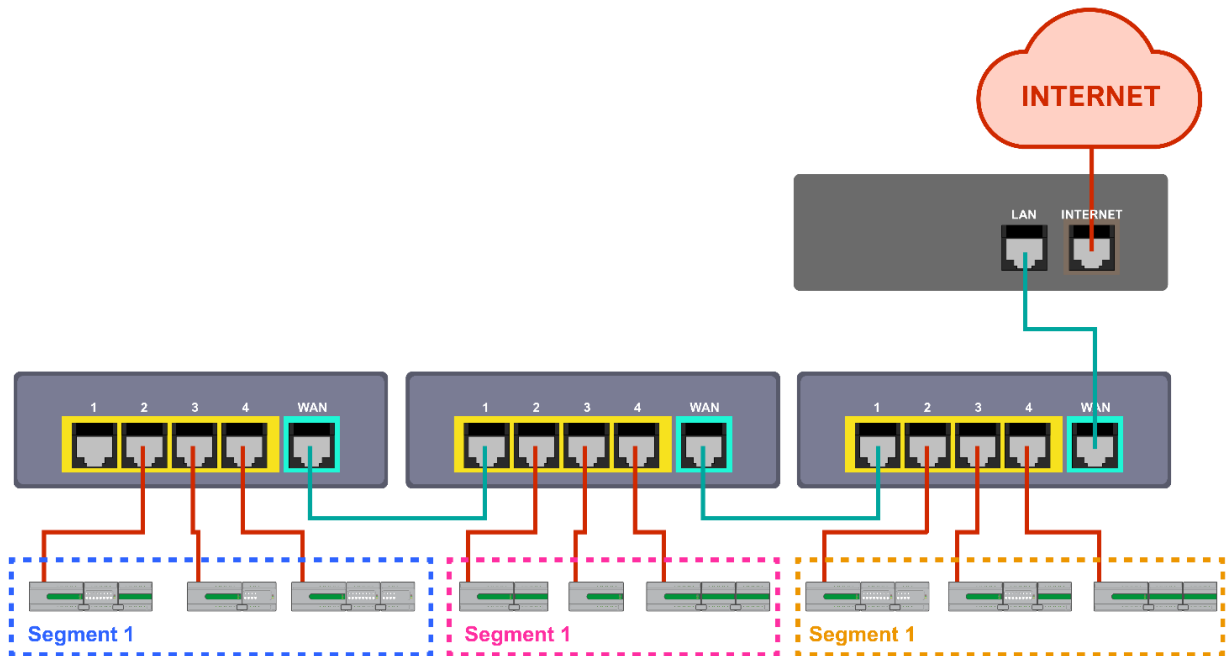

If routers are connected without using their “WAN” or “UPLINK” ports, the result is a single segment:

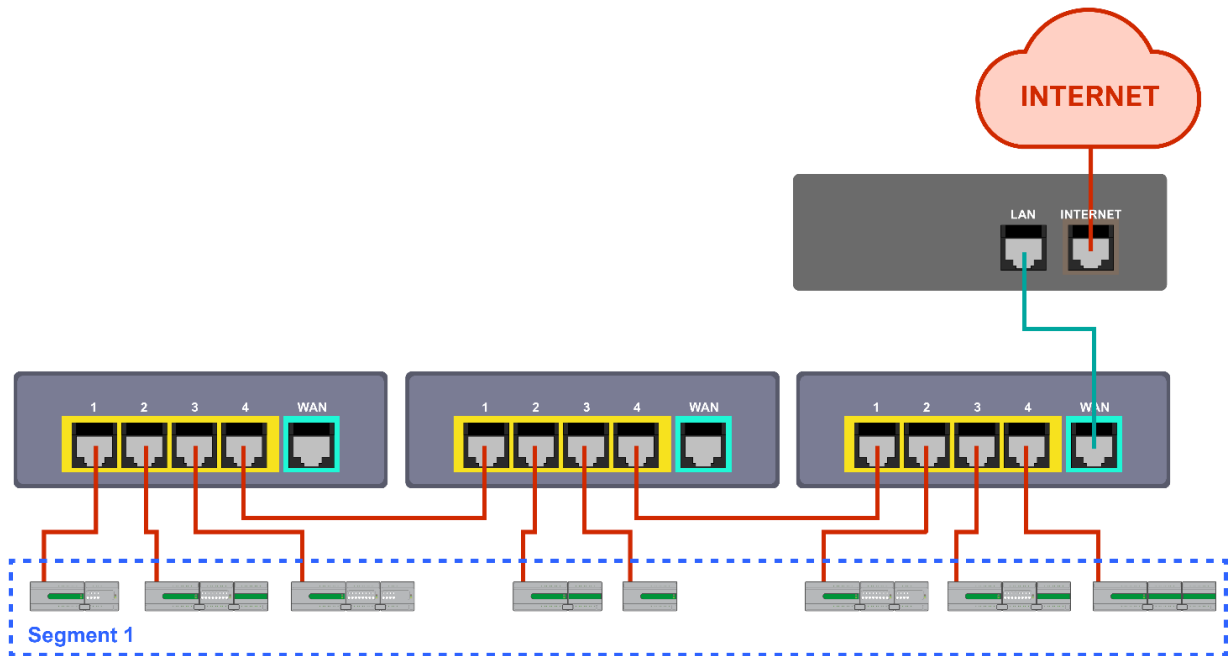

## NETWORK ADDRESS TRANSLATION (NAT)

Network Address Translation is a function of a router or firewall, which maps multiple local IP addresses to a single public IP address. This is necessary because the number of IPv4 addresses is finite.

## DOMAIN NAME SYSTEM (DNS)

When communicating on the wider Internet, it can be difficult to remember the numeric IP address for each device with which you want to communicate. The Domain Name System (DNS) was created to allow internet users to use a text-based Uniform Resource Locator (URL) with meaningful values such as “www.cylon.com” to connect to a site or device without having to know the server’s IP address. The DNS finds the URL in its distributed database and passes the corresponding numeric IP address to the requesting device. If a device’s IP address changes, the DNS server can be updated with its new IP address, ensuring that other networked devices can still find this device from its URL.

When setting a device’s IP parameter manually, between one and three DNS IP address are usually provided. The second and third addresses are used if the first DNS becomes unavailable.

If you do not know the address of your DNS server(s), you can use publicly available DNS server addresses for example primary = 8.8.8.8 and secondary = 4.4.4.4

# 3 BACnet Networking

## WHAT IS BACNET?

BACnet is "a data communication protocol for building automation and control networks." This means it is a set of rules for exchanging BMS information between systems from different manufacturers.

The rules take the form of a written specification that spells out what is required to conform to the protocol

The key feature of BACnet is that the rules relate specifically to the needs of building automation and control equipment - for example, how to ask for the value of a temperature, define a fan operating schedule, or send a pump status alarm.

BACnet provides a standard way of representing the functions of any device - for example analog or binary inputs or outputs, schedules, control loops and alarms.

The standardized model of a device represents these common functions as collections of related information called objects

Each object has a set of properties that further describe it. Each analog input, for instance, is represented by a BACnet "Analog Input object", which has a set of standard properties such as 'Present Value', 'Sensor Type', 'Location', 'Alarm Limits' etc. Some of these properties are required, while others are optional.

The only required object in each BACnet controller is the Device object. This object contains the properties that define the controller's behavior on the network. Each controller's Device object has an associated number called the Device Instance. It is this unique number that allows all other BACnet devices to unambiguously access the controller.

Here is an illustration of BACnet objects:

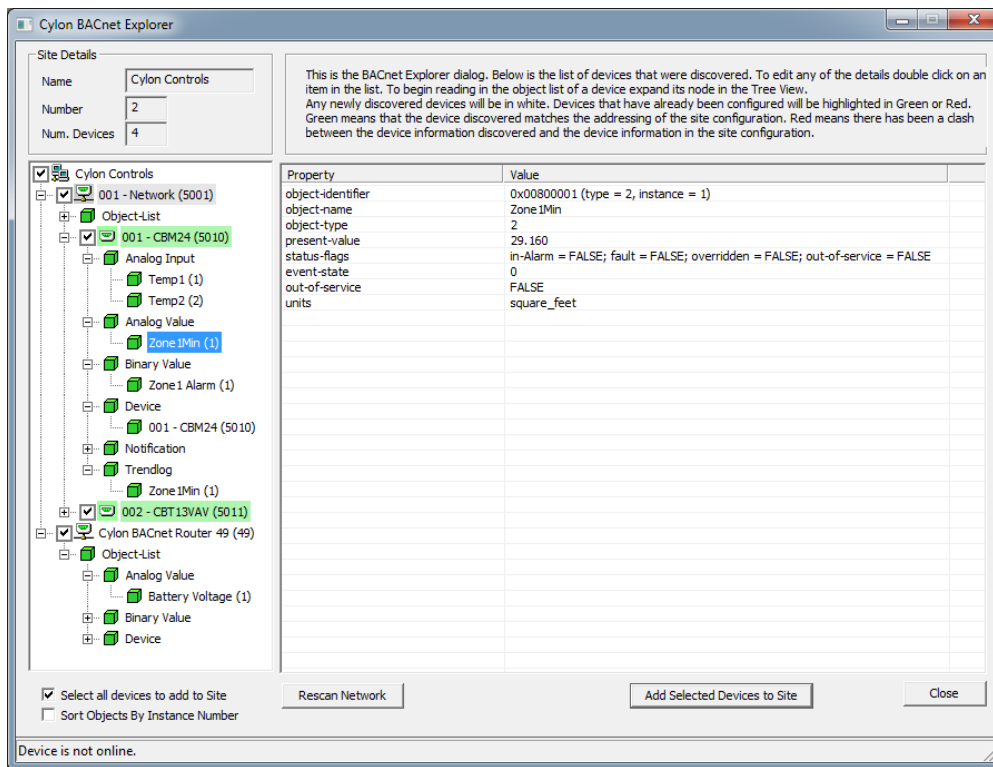

## BACNET OBJECT TYPES

The BACnet standard defines a number of standard object types, and this number is increasing over time. Cylon uses the following standard types (\* indicates that the object is proprietary):

- Device
- Analog Input
- Analog Value
- Analog Output
- Binary Input
- Binary Value
- Binary Output
- Schedule
- Calendar
- Unitron Schedule \*
- Notification Class
- File
- Trend Log
- Manufacturing Object \*

## BACNET SERVICES

The BACnet standard defines numerous services for interaction between BACnet devices. The following are supported by Cylon BACnet products:

- ReadProperty
- WriteProperty
- ReadPropertyMultiple
- WritePropertyMultiple
- Read Range
- Whols
- IAm
- WhoHas
- IHave
- UnconfirmedPrivateTransfer
- TimeSynchronization
- UTCTimeSynchronization
- DeviceCommunicationControl
- ReinitializeDevice
- AtomicWriteFile
- AtomicReadFile
- AcknowledgeAlarm
- GetAlarmSummary
- GetEventInformation
- ConfirmedEventNotification
- UnconfirmedEventNotification
- SubscribeCOV
- ConfirmedCOVNotification
- UnconfirmedOVNotification

## BACNET'S CLIENT / SERVER NATURE

BACnet uses a "Client/Server" architecture. BACnet messages are called service requests. A Client machine sends a service request to a Server machine that then performs the service and reports the result to the Client.

### Example:

A simple device such as a fixed function VAV controller would typically act as Server.

Front-end software running on a PC would act as a BACnet Client reading status values from the VAV and changing set-points.

### Notes:

Server devices cannot initiate communication. Higher end embedded controllers generally include both server and client functionality. This allows them to share information such as outside temperature with each other or send alarms to a PC.

BACnet currently defines 35 message types that are divided into 5 groups or classes. For example, one class contains messages for accessing and manipulating the properties of the objects described above.

A common message type is the "ReadProperty" service request. This message causes the server machine to locate the requested property of the requested object and send its value back to the client.

Other classes of services deal with: alarms and events, file uploading and downloading, managing the operation of remote devices and virtual terminal functions.

## NETWORK TYPES

BACnet messages can be carried over the following types of network:

- Ethernet
- ARCnet
- Master-Slave/Token-Passing (MS/TP)
- Point-to-Point (PTP)
- LON
- BACnet/IP

## PIC STATEMENT

Every BACnet device is required to have a "protocol implementation conformance statement" (PICS). A PICS is a BACnet specification sheet, containing a list of a device's BACnet capabilities.

It contains:

- a general product description
- details of a product's BACnet capabilities
- which LAN options are available
- a few other items relating to character sets and special functionality

The PICS is the place to start to see what a device's capabilities are.

## BACNET TOPOLOGY

A typical BACnet Network consists of devices connected to physical networks. Each device is a separate piece of hardware and has a physical connection to the network. Devices are given a unique Device Instance Number which can be a number between 0 and 4194302. BACnet MS/TP devices have additional addressing designations called MAC addresses. For most users it is the Device Instance Number which is used as a reference, but the combination of the Network Number and MAC address of an MS/TP device may be configured by a System Integrator to avoid any MAC address conflicts on the EIA-485 network.

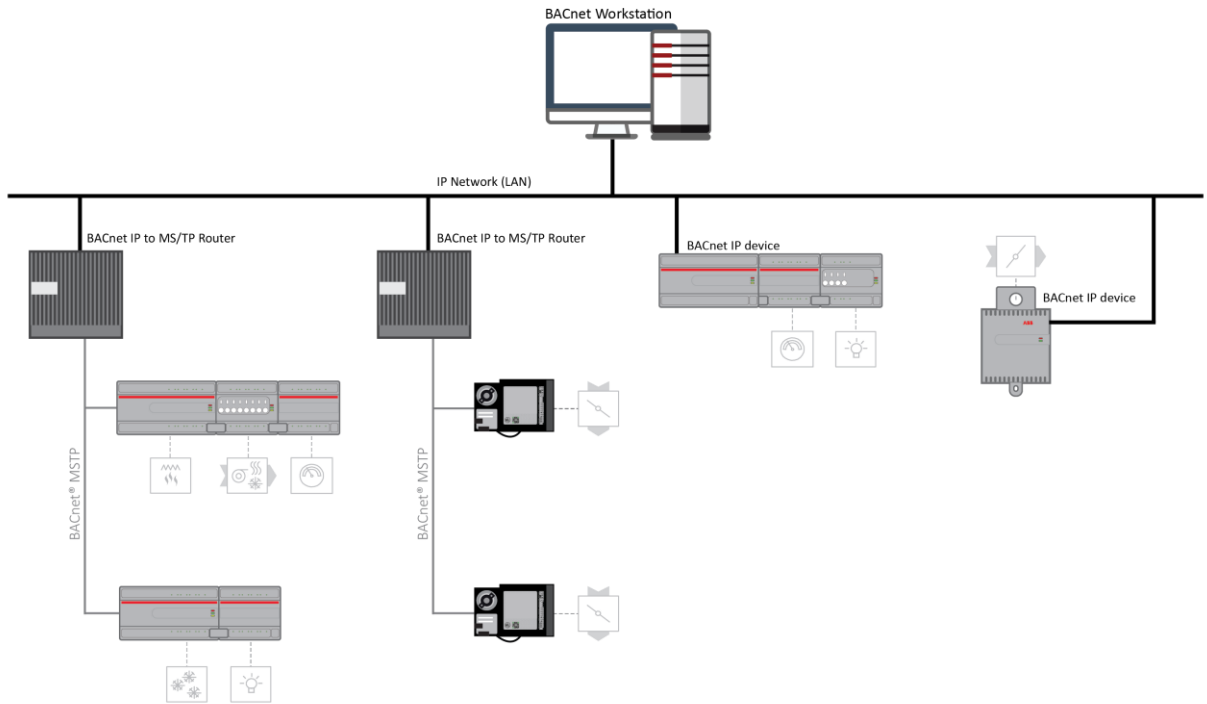



## BACNET IP

BACnet/IP uses the User Datagram Protocol (UDP) to send data packets. ASHRAE adopted BACnet/IP in [annex j of the 135-1995 standard](#).

BACnet/IP communicates using four methods.

- BACnet/IP to BACnet/IP (same subnet): Assuming that two devices know each other's IP addresses and the UDP ports they are using, i.e., their respective B/IP addresses, there is nothing that restricts them from communicating directly.
- BACnet/IP to BACnet/IP (different subnet): The location of the two devices is already known by the host and the message is routed to the device using switches and routers.
- Broadcast (same subnet): This is a standard Who is/ I am message sent across a local subnet for the BBMD to discover what the address are for the BACnet devices on the subnet.
- Broadcast (different subnet): This is a standard Who is/ I am message sent across a local subnet for the BBMD to discover what the address are for the BACnet devices on other subnets.

## BACNET IP BROADCAST MANAGEMENT DEVICE (BBMD)

Some BACnet services use “broadcasts” (e.g. “Who-Is”). On a LAN with standard routers, these broadcasts are “blocked”. Thus, BACnet broadcasts are limited to the IP Subnet of the BACnet device. With a BACnet/IP network of 2 or more IP subnets, a device with BBMD can be used.

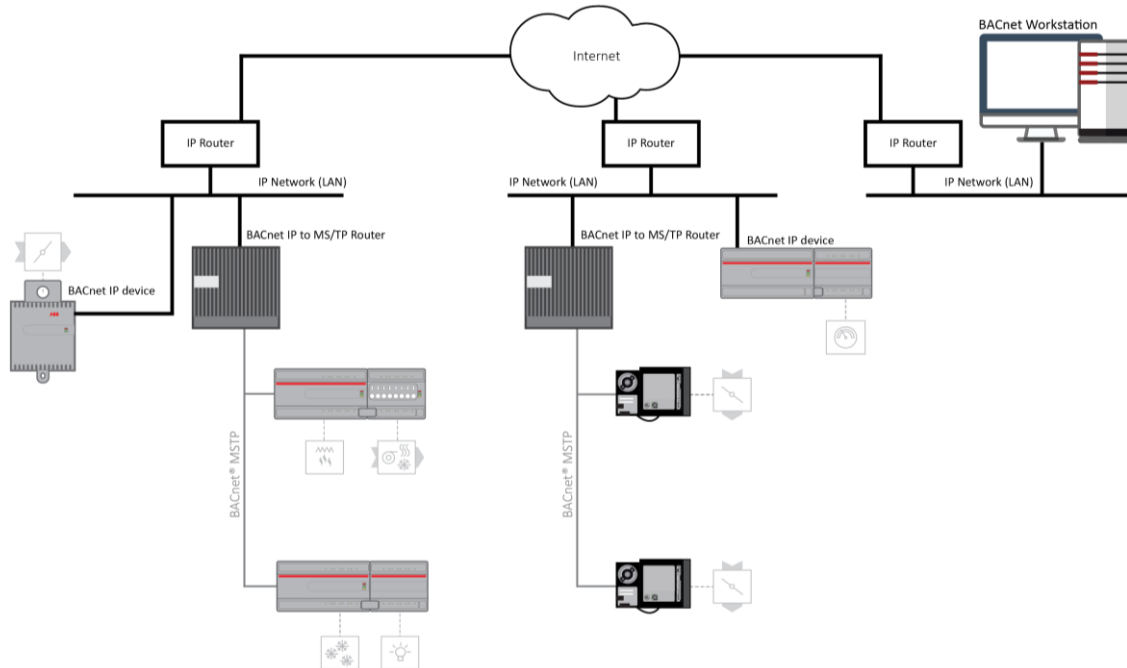

A BBMD located on an IP subnet monitors the origin of a broadcast message on that subnet and, in turn, constructs a “peer to peer” message in order to pass through an IP router. This “peer to peer” message is received by other BBMDs on other IP subnets and transmitted as a broadcast on their attached subnets.

Since the BBMD messages are directed messages, individual messages must be sent to each BBMD. Each BBMD device maintains a *Broadcast Distribution Table (BDT)*, the content of which is usually the same for all BBMDs within the network. BBMDs must know the IP address of all other BBMDs in the network.

It is possible to communicate to a device on a subnet that does not have a BBMD as in the BACnet Workstation example above. This type of device is called a foreign device since it resides on a different IP subnet from devices attempting to communicate with it.

Usually, in BACnet/IP, a foreign device is on a different subnet.

The foreign device (e.g. BOWS) registers with each BBMD, after which it can communicate with all other devices on the network. The BBMD then maintain a Foreign Device Table (FDT) which keeps track of foreign devices.

## BACNET MS/TP

BACnet MS/TP (Master-Slave Token Passing) is an EIA-485 network layer intended for use with lower-level devices such as Unitary Controllers. In comparison to BACnet/IP and BACnet/Ethernet, MS/TP is more cost-effective to implement due to the lower cost of wiring. Given the MS/TP network is a serial-based network, devices may be configured to communicate at different baud rates specified by BACnet. Therefore, it is essential to know information regarding the BACnet network you are connecting to before installing.

## TOKEN PASSING

BACnet MS/TP uses token passing to allow devices to communicate on the network. Token passing is controlled by each device, which contains an internal memory list of other MS/TP peers connected to the network. The token is passed in order of the MAC Address (Unit ID) from lowest to highest. In most MS/TP networks, each device is configured to be a master. Given all devices may be a master, MS/TP may appear and react slower than traditional building automation protocols. However, configuring your network for faster baud rates will help provide better bandwidth and transport speed of network messaging.

Token passing is a communications scheme that allows connected devices connected to intercommunicate with one another. A network “token” is passed from unit to unit on the network in a round-robin fashion by order of the MAC Address (lowest to highest) to provide a transport to access the network. When a unit possesses the token, it may perform any network activity for which it is responsible. When finished, the token is then passed onto the next device. At any time, the unit that possesses the token is the only device permitted to initiate communications with another device on the network or to request information from it. A device that receives the token may or may not need to perform network functions (e.g. read values from a remote device, broadcast information, etc.). If not, it will simply pass the token along the network.

If you are connecting devices to an existing MS/TP network consisting of third-party devices, consult third-party vendor documentation regarding MS/TP network considerations.

## ADDRESSING

BACnet MS/TP devices contain two device addresses. One device address is known as a Device Instance, and the other is a MAC Address. The Device Instance is an address assignment that is used to identify the BACnet device on a global BACnet network. When a device is connected to a global BACnet network consisting of multiple data layers joined together using routers, the Device Instance is used to uniquely identify the device on a global basis. The valid range for the device instance in a BACnet device is 0 to 4,194,302. Devices must be configured for a unique, non-conflicting Device Instance. In the event that multiple devices are assigned the same Device Instance, both devices will simply not communicate on the BACnet network or could be subject to misdirected messaging (a message intended for Device-A may be routed to Device-B)

The MAC Address is an address assignment used within the BACnet MS/TP segment to permit a device to actively communicate on the BACnet MS/TP network. Valid MAC Address assignments range from 0 to 127 and are typically assigned in a logical and incremental order to permit faster token passing between devices. The MAC Address of a BACnet MS/TP device must be a unique, non-conflicting value that exists on the local MS/TP network. In the event that multiple devices are assigned with the same MAC Address, the effects can be far detrimental than that of a conflicting Device Instance; potentially resulting in a failure of the entire local MS/TP network. In the event that the unitary controller encounters a duplicate of its MAC Address, devices will inform the user that a duplicate MAC Address has been detected and will not perform client communications until resolved.

## BAUD RATES

As a serial-based protocol, BACnet MS/TP supports the following four baud rates: 9.6kbps, 19.2kbps, 38.4kbps, and 76.8kbps. Devices can be configured for any of these baud rates, as well as native PC baud rates 57.6kbps and 115.2kbps which are currently not supported by the BACnet standard. Each device communicating on an MS/TP network must be configured for the same baud rate at all times.

## NETWORK OPTIMIZATION

In BACnet MS/TP devices, specific device properties are available to permit optimization. Network communications. By adjusting Device properties max-master and max-info-frames, users can adjust the token passing abilities of devices. The functionality of these two properties is described as follows:

- **Max-Master** - defines the highest unit ID of an MSTP master that is connected to the network. This value specifies to what address extent a token may pass. For example, if you have 64 devices addressed in a logical order, this value would be assigned to 64. This value should be set to the same value across all devices connected to an MSTP network.
- **Max-Info-Frames** - defines the number of data frames that an MSTP master can use the token before passing onto the next device. This value is typically set by the factory but can be modified if necessary. In the event a device does not need to keep the token for the number of frames specified, devices will automatically pass the token onto the next device.

## BACNET MS/TP DEVICE LOADING

MS/TP (Master-Slave Token Passing) is a protocol where each device is wired in series and they take turns communicating, depending on which device currently holds a “token”. It is a robust design, and simpler/cheaper than IP though less flexible in terms of interoperability.

BACnet MS/TP is widely used in building automation, and usually uses RS-485 networking. As a result, the number of devices that can be connected together (on a “trunk” or “Fieldbus”) is limited by the electrical load the device puts on the network.

Unit Load is a concept created by the RS-485 specification to help determine how many devices can be connected to each fieldbus. The number of devices that can be connected depends on how much each device loads the fieldbus so the more a device loads the fieldbus, the fewer additional devices can be used. The total Unit Loads on a fieldbus must be 32 or less.

BACnet MS/TP allows 127 master device addresses, but the Unit Loading usually prevents that number of devices being active on a fieldbus.

## READ PROPERTY MULTIPLE

A single BACnet request can contain a sequence of BACnet property references, each representing a single BACnet property. This allows multiple properties to be read with a single BACnet request.

By default, FBXi will read 5 properties at once.

## BACNET PRIORITY ARRAY

BACnet uses a command prioritization scheme for objects that control equipment or software parameters that affect the operation of equipment connected to devices. The use of this command prioritization scheme (commonly referred to as Priority Array) allows a device to determine the order in which an object is controlled. Command Prioritization assigns unique levels of priority to the different types of devices that can write values to a device. There are 16 prioritization levels with Level 1 being highest and Level 16 the lowest. For example:

Priority Level	Application	Priority Level	Application
1	Manual-Life Safety	9	Available
2	Automatic-Life Safety	10	Available
3	Available	11	Available
4	Available	12	Available
5	Critical Equip. Control	13	Available
6	Minimum On/Off	14	Available
7	Available	15	Available
8	Manual Operator	16	Available

BACnet defines the types of objects that are either required or may optionally support the command prioritization scheme.

# 4 FBXi Web UI

## SUMMARY DASHBOARD

The Summary Dashboard displays the controller status including important information such as firmware versions and I/O status.

The screenshot shows the ABB FBXi Web UI interface. At the top, the device name is "FBXi 40002 192.168.5.213". The left sidebar contains navigation options: Dashboard, BACnet, Device, Router Networks, Time Sync, BBMD / NAT, IP Network, RS 485 Ports, Platform, and Diagnostics. The main content area is titled "Controller Status" and contains the following information:

Controller Name	FBXi 40002
Device ID	40002
Serial Number	FBXi040002G
MAC	14:42:fc:c0:ab:c6
Blocks Servicing	2000
Servicing Runtime	928634
Stat Device	No Stat Present

I/O Device	Status
Flex: 0	8R8 Not Detected
Flex: 1	8R8 Not Detected
Flex: 2	8R8 Not Detected
Flex: 3	8R8 Not Detected
Flex: 4	8R8 Not Detected
Flex: 5	8R8 Not Detected
Flex: 6	8R8 Not Detected
Flex: 7	8R8 Not Detected
Flex: 8	8R8 Not Detected
Flex: 9	8R8 Not Detected

**Versions**

Strategy Engine	8.3.0-a6 20200924-0727
System Supervisor	8.3.0-a6 20200924-0727
BACnet Router	8.3.0-a6 20200924-0727
Linux Kernel	5.4.27-yocto-standard

**License Status**

Hardware ID	c6abc0fc4214
License ID	c6abc0fc4214
ID Matches License	
License Is Valid	

# BACNET MENU

## DEVICE

The BACnet Device Name and Device ID are set from this page.

## ROUTER NETWORKS

BACnet Network numbers are used to identify the “wire” to which the device is attached.

- For IP, all devices on the local LAN must have the same BACnet Network number.
- For MS/TP devices, each serial bus line must have a unique BACnet Network number.

BACnet network numbers are used to identify the "wire" that the device is attached to. For IP, all devices on the local LAN must have the same BACnet network number. For MS/TP devices, each serial line must have a unique network number.

Port	Enabled	Network	Edit Details
IP	<input checked="" type="checkbox"/>	500	
MSTP 1	<input checked="" type="checkbox"/>	213	
MSTP 2	<input checked="" type="checkbox"/>	1245	
NAT	<input type="checkbox"/>	504	
Raw Ethernet	<input type="checkbox"/>	501	

## TIME SYNC

BACnet Time Synchronization messages can be sent from this device to any BACnet device in order to ensure that those devices have the correct times.

- The **Transmit Options** control how often and when to send.
- The **Destinations** list the targets to which the Time Sync messages will be sent.

Time Sync messages can be broadcast to an entire network if desired.

**ABB** Device name: **FBXi 40002 192.168.5.213**

**BACnet Time Sync**

BACnet time synchronization messages can be sent from this device to any BACnet device in order to insure other devices have proper times. The Transmit Options control how often and when to send. The destinations list the targets to send to. Time Syncs can be broadcast to an entire network if desired.

**Transmit Options**

Frequency (min)

Align Sending  If enabled then time syncs are transmitted at the designated (offset) minutes past start of day or hour.

Offset (min)

**Local TimeSync Destinations**

Target	Network	Device	+
--------	---------	--------	---

**UTC TimeSync Destinations**

Target	Network	Device	+
--------	---------	--------	---

## BBMD / NAT

BBMD connects BACnet IP networks that are not on the same local network (see *BACnet IP*

*BACnet/IP uses the User Datagram Protocol (UDP) to send data packets. ASHRAE adopted BACnet/IP in annex j of the 135- 1995 standard.*

BACnet/IP communicates using four methods.

- BACnet/IP to BACnet/IP (same subnet): Assuming that two devices know each other's IP addresses and the UDP ports they are using, i.e., their respective B/IP addresses, there is nothing that restricts them from communicating directly.
- BACnet/IP to BACnet/IP (different subnet): The location of the two devices is already known by the host and the message is routed to the device using switches and routers.
- Broadcast (same subnet): This is a standard Who is/ I am message sent across a local subnet for the BBMD to discover what the address are for the BACnet devices on the subnet.
- Broadcast (different subnet): This is a standard Who is/ I am message sent across a local subnet for the BBMD to discover what the address are for the BACnet devices on other subnets.

BACnet IP Broadcast Management Device (BBMD) on page 17 for details).

NAT connects sites where there is a NAT gateway between them.



## IP NETWORK MENU

### CONFIGURATION

This page allows basic IP configuration, identifying the current device on the IP network.

If your network has a DHCP server, click the **Automatic (DHCP)** box. You can then use BACnet discovery to list controllers along with their IP addresses, and can use the hostname to identify the IP address of a specific controller. By default, all **FBXi** devices leaving the factory are configured to use DHCP, and have a hostname set to “**FBXi**” followed by the controller’s serial number – e.g. **FBXi901004A**

If your network does not have a DHCP server, then the **FBXi** controller will use a default IP address, which is made up as follows:

- The first byte of the IP address is set to 10
- The 6 digits of the numerical part of the serial number grouped into 3 sets of 2 digits to form the last 3 bytes of the IP address.

For example, **FBXi** with serial number **901001A** will be allocated the default IP address of **10.90.10.01**. See also *Configuring the IP connection* on page 39. The **IP Address** input is also used to specify the subnet mask in CIDR format. See *Subnetwork (Subnet)* on page 8 for a full explanation.

#### Recovery IP Address

If the primary IP cannot be reached – for example if the primary is set to automatic and there is no DHCP server available, then the user must use the Recovery IP Address to access the Web UI and properly configure the primary. The recovery is only designed for access to the web UI.

The factory default value is based on the serial number in the same way as the primary, but the Recovery IP Address should **not** be changed or disabled unless it interferes with other network operations.

**Note:** A button-press reset (see *Restarting, Resetting and upgrading the FBXi* on page 78 will revert all IP configuration to factory defaults.

### TCP/UDP PORTS

This page defines IP ports that are open to the outside world, and the protocols those ports expect to use. HTTPS/HTTP are used for this web configuration.

- HTTPS is always enabled, though the port can be changed if required.
- HTTP is disabled by default.

The BACnet ports are needed if the controller must communicate with other BACnet controllers over IP.

ABB Device name: FBXi 40002 192.168.5.213

#### IP Network TCP/UDP Ports

IP Network TCP and UDP ports are ports open to the outside world. HTTPS/HTTP are used for this web configuration. HTTPS is always enabled, though the port can be changed if required. HTTP is disabled by default. The BACnet ports are needed if the controller must communicate with other BACnet controllers over IP.

Protocol	Enabled	Number
https	<input checked="" type="checkbox"/>	443
http	<input type="checkbox"/>	80
BACnet	<input checked="" type="checkbox"/>	47808
BACnet NAT	<input checked="" type="checkbox"/>	47809

Cancel Submit

### EDIT SSL CERT / SIGN SSL CERT

The IP Network > Edit SSL Cert page allows you to enter the details for an SSL certificate, which can be applied to the current FBXi as a self-signed certificate, or else these details can be used to generate a request for a 3rd-party SSL Cert on the IP Network > Sign SSL Cert page

ABB Device name: FBXi 40002 192.168.5.213

**Edit SSL Certificate / Request**

Edit the information inside the SSL certificate.

- For self signed certificates, this replaces the existing certificate. This information will be displayed by a browser when the user requests to view the certificate.
- For CA signed certificates, this creates the certificate signing request to provide the CA.

Self Signed Certificate  CA Certificate Request

Common Name:  The host/domain name of this controller

Organization:

Organization Unit:

Country:  Two letter country code

State/Province:

City/Locality:

To install a 3<sup>rd</sup>-party SSL Cert, or to generate a request for a 3<sup>rd</sup>-party SSL Cert, use the IP Network > Sign SSL Cert page:

**Install Signed SSL Certificate**

The certificate supplied with the system is self-signed. It will properly encrypt messages to prevent another party from viewing the information being transferred. However, it will not prove that the device is who it claims to be. This causes browsers to display a security warning when accessing the site.

Having the certificate properly signed by a trusted CA will avoid this warning. To do this:

- Use the Edit Certificate menu selection to insure that the identification information is proper.
- Download the certificate signing request.
- Have the request signed by the CA.
- Upload the signed certificate.

**Download Certificate Signing Request**

The downloaded request (.csr) will include your identification information as entered in the Edit SSL Certificate screen.

The Common Name in the certificate must match the FQDN of this controller. I.E.: thiscontroller.yourcompany.com

[Download](#)

**Install Signed Certificate**

The file to be installed is a .PEM text file. The file consists of the signed server certificate followed by the intermediate certificate used to sign it.

[Install](#)

## RS-485 PORT MENU

### CONFIGURATION

The two RS-485 ports can be configured for BACnet or Modbus on the RS 485 > Configuration page, and the baud rate can be set as appropriate. See *Configuring a Modbus RTU connection* on page 59 for more detail.

Port 2 can also be set to Cylon Room Sensor by selecting the “Stat” option.

Port #	Function	Baud
1	BACnet/MS	38400
2	Stat	38400

[Cancel](#)

### STATUS

The status of the ports can be viewed on the RS 485 > Status page. It includes the number of characters transmitted (TX), and also received errors (FE), for each of the two RS-485 ports.

Port	TX	RX	FE	PE
1	72075206	506386843	1763 6864	0
2	0	0	0	0

**Note:** If the FE value is a large percentage of the TX value (for example > 10 %), it may be beneficial to review your wiring for correct termination or unexpected line breaks.

### SERIAL CAPTURES

If required for diagnosing errors or tuning network performance, the FBXi can capture serial port communications and store it in a file that can be analysed using WireShark.

This is done through the RS-485 Ports > Serial Captures dialog:

**Create Capture File**

This creates a capture file for data on the serial ports. The file, once downloaded to your PC, may be viewed by wireshark

**Capture Control**

Serial Port: 1

Max. Time (secs.): 60

Max. Size (Kb): 100000

Filename: serial

**Capture Status**

Status: Idle

Capture Time (secs.):

Capture Size:

Start Stop Download

# PLATFORM MENU

## STATUS REPORT

The Platform > Status page is useful for technical support and shows the Up-Time (running time) of the FBXi and its serial number, along with the versions of various software components of the FBXi. Memory usage is also displayed.

Device name: **FBXi 40002 192.168.5.213**

**Platform Status**

**System Information**

- Up-Time: 10 Days, 22 Hours, 22 Minutes
- Serial Number: FBXi040002G
- Load Averages: 0.00 : 0.01 : 0.00

**Versions**

- Strategy Engine: 8.3.0-a6 20200924-0727
- System: 8.3.0-a6 20200924-0727
- Supervisor
- BACnet Router: 8.3.0-a6 20200924-0727
- Linux Kernel: 5.4.27-yocto-standard

Resource Usage	Used	Max	Percent
Memory	61.34 MB	504.6 MB	<div style="width: 12%;"></div>
/	0.204 GB	3.487 GB	<div style="width: 6%;"></div>
/run	17.17 MB	252.3 MB	<div style="width: 7%;"></div>
/tmp	0.004 MB	252.3 MB	<div style="width: 0%;"></div>
/var/volatile	0.044 MB	252.3 MB	<div style="width: 2%;"></div>

## FIRMWARE UPGRADE UTILITY

With assistance from technical support, you may upgrade the firmware of the FBXi. Please be sure to back up your system before commencing the upgrade.

**Note :** The controller will be out of service while being upgraded.

To upgrade, click Platform > Upgrade Firmware and an Open File dialog will appear. Find the .iam file that you would like to upload. Once uploading has started, your system will be out of service. After approximately 30 seconds, your system will be online with the new firmware.

Device name: **FBXi 40002 192.168.5.213**

**Platform Upgrade Firmware**

The firmware is updated from a ".bin" file that must be downloaded to your PC. Please read the release notes associated with the upgrade file.

**CAUTION!** Insure your system is backed up prior to upgrade. Note that controller will be out-of-service while being upgraded

[Upgrade Bundle](#)

Status: Ready

### BACKUP/RESTORE UTILITY

You may perform a full backup to a file that can be downloaded to your PC. This includes Strategy data, BACnet settings and system settings configured via this web interface. Simply click the **Download Backup from Controller** button and save the backup to your PC.

**Note:** This backup cannot be used by CXproHD to edit a restored Strategy

You may also restore a backup to the FBXi. By clicking the **Restore Backup to Controller** button. An **Open File** dialog will appear. Find the appropriate backup file and select it for restoring. After a few moments, the controller will restart with the new Strategy and data.

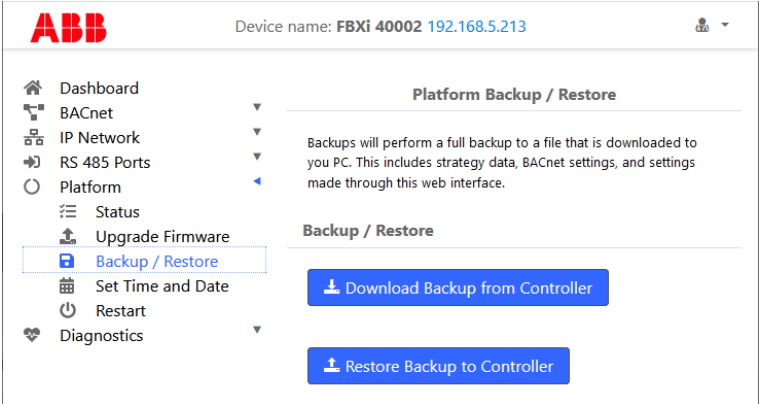

### SET TIME AND DATE

On most networks, NTP is used to automatically keep the time and date correct. Enabling it generally requires no additional configuration.

Some private networks may have an NTP server that cannot be automatically located. If so, check the **Use Custom Server** box and enter the hostname of the NTP server if available. If an NTP server is not available, the time can be manually set.

**ABB** Device name: **FBXi 40002 192.168.5.213**

- Dashboard
- BACnet
- IP Network
- RS 485 Ports
- Platform
- Status
- Upgrade Firmware
- Backup / Restore
- Set Time and Date**
- Restart
- Diagnostics

#### Platform Set Time and Date

On most networks, NTP is used to automatically keep time/date. Enabling it generally requires no additional options.

Some private networks might have an NTP server that can not be automatically located. If so, check the "Use Custom Server" box and enter the hostname of the NTP server.

If NTP is not available, the time can be manually set.

#### NTP Time Service

Enabled  Synchronized

Use Custom Servers

Custom Servers

#### Date and Time

2020-10-23  Use desktop date/time

08 : 53 : 09

#### Time Zones

EST5EDT



### RESTART UTILITY

Several options are available for refreshing the FBXi platform, in case a condition has occurred which stopped a portion of the functionality of the FBXi and you do not wish to reboot the entire FBXi platform.

- Choose **Reboot Platform** to cleanly shutdown the FBXi and then restart it. This is equivalent to rebooting your PC.
- Choose **Restart Strategy Engine** to stop and restart the processing of the Strategy.
- **Restart the BACnet Router and MSTP** stops and restarts the internal BACnet Router and MS/TP network engine.

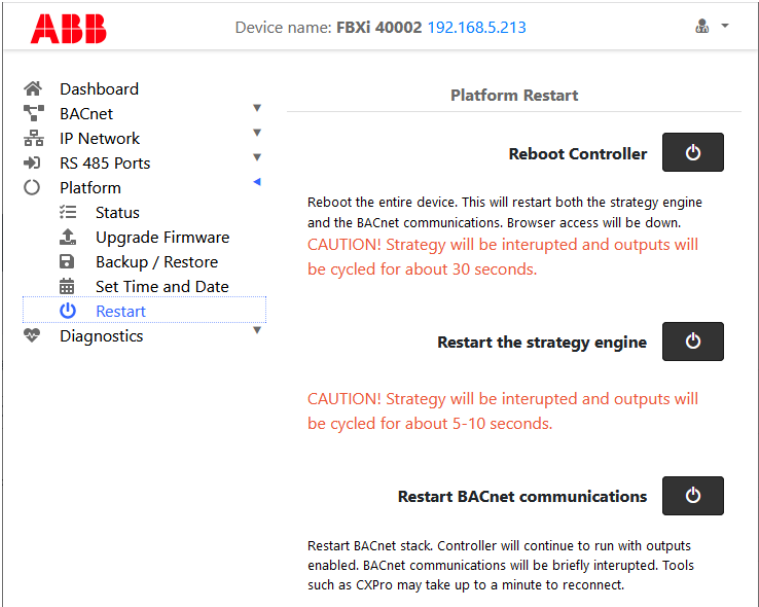

# DIAGNOSTICS MENU

## PROCESSES

The Diagnostic > Processes page displays a list of the processes that are running in the FBXi. If requested by Technical Support, a screenshot of this page can be useful in diagnosing certain types of problems.

Device name: **FBXi 40002** 192.168.5.213

Mem: 157756K used, 346844K free, 17228K shrd, 11912K  
 CPU: 0% usr 0% sys 0% nic 100% idle 0% io  
 Load average: 0.10 0.04 0.01 1/98 7336

PID	PPID	USER	STAT	VSZ	%VSZ	%CPU	COMMAND
7336	213	root	R	2744	1%	0%	top -b -n 1
213	1	root	S	149m	30%	0%	/usr/bin/nc
240	1	root	S	97800	19%	0%	/usr/local/
225	1	root	S	81996	16%	0%	/usr/local/
183	1	root	S	36748	7%	0%	/usr/local/
133	1	root	S	30544	6%	0%	/lib/system
1	0	root	S	24976	5%	0%	{systemd} /
165	1	systemd-	S	15460	3%	0%	/lib/system
153	1	root	S	13532	3%	0%	/lib/system
131	1	root	S	12464	2%	0%	/usr/sbin/r
217	216	www	S	7312	1%	0%	nginx: work
190	1	systemd-	S	6596	1%	0%	/lib/system
216	1	root	S	6580	1%	0%	nginx: mast
206	1	systemd-	S	6132	1%	0%	/lib/system
205	1	root	S	5908	1%	0%	/lib/system
177	1	messageb	S	4112	1%	0%	/usr/bin/dt
178	1	root	S	3912	1%	0%	/sbin/aget
214	1	root	S	2328	0%	0%	/usr/sbin/v
180	1	root	S	1864	0%	0%	/sbin/aget
9	2	root	SW	0	0%	0%	[ksoftirqd/
10	2	root	IW	0	0%	0%	[rcu_preemp
114	2	root	SW	0	0%	0%	[jbd2/mmcbl
207	2	root	SW	0	0%	0%	[ptp0]
7202	2	root	IW	0	0%	0%	[kworker/0:
7201	2	root	IW<	0	0%	0%	[kworker/0:
7290	2	root	IW	0	0%	0%	[kworker/u2
2	0	root	SW	0	0%	0%	[kthreadd]
7292	2	root	IW	0	0%	0%	[kworker/u2
7329	2	root	IW	0	0%	0%	[kworker/u2
106	2	root	SW	0	0%	0%	[irq/35-486
7328	2	root	IW	0	0%	0%	[kworker/0:
3	2	root	IW<	0	0%	0%	[rcu_gp]
4	2	root	IW<	0	0%	0%	[rcu_par_gp
8	2	root	IW<	0	0%	0%	[mm_percpu_
11	2	root	SW	0	0%	0%	[kdevtmpfs]
12	2	root	SW	0	0%	0%	[kmemcg-1]

### DEBUG LEVEL

If directed by Technical Support, you can change the debug levels to assist in troubleshooting difficult field problems should the need arise.

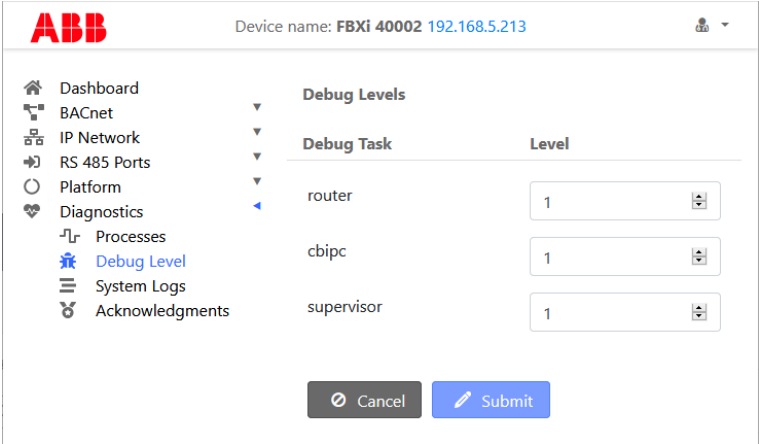

### SYSTEM LOGS

If directed by Technical Support, a download of the system log may assist in troubleshooting difficult field problems should the need arise. The **Download** button will instruct you to save the file to your PC, from where you can email it to Technical Support.

Device name: **FBXi 40002** 192.168.5.213

**System Log** [Download] [Refresh]

```
-- Logs begin at Mon 2020-10-12 10:25:55 EDT, end at
Oct 23 08:53:39 systemd[1]: systemd-timedated.service
Oct 23 08:53:09 systemd[1]: Started Time & Date Servi
Oct 23 08:53:09 dbus-daemon[177]: [system] Successful
Oct 23 08:53:09 systemd[1]: Starting Time & Date Serv
Oct 23 08:53:09 dbus-daemon[177]: [system] Activating
Oct 23 08:49:31 node[213]: Exists: true
Oct 23 08:33:41 node[213]: Exists: true
Oct 23 07:34:11 node[213]: Exists: true
Oct 23 06:25:50 cbipc[225]: Rebuild databases performe
Oct 23 06:25:49 cbipc[225]: IOX runtime init. T=935€
Oct 23 06:25:47 cbipc[225]: IOX runtime init. T=935€
Oct 23 06:25:02 cbipc[225]: IOX runtime init. T=935€
Oct 23 06:24:09 cbipc[225]: Rebuild databases performe
Oct 23 06:24:08 cbipc[225]: IOX runtime init. T=935€
Oct 23 06:24:08 cbipc[225]: IOX runtime init. T=935€
Oct 23 06:24:06 cbipc[225]: IOX runtime init. T=935€
Oct 23 06:23:21 cbipc[225]: IOX runtime init. T=935€
Oct 23 06:22:57 cbipc[225]: Rebuild databases performe
Oct 23 06:22:56 cbipc[225]: IOX runtime init. T=935€
Oct 23 06:22:56 cbipc[225]: IOX runtime init. T=935€
Oct 23 06:22:54 cbipc[225]: IOX runtime init. T=935€
Oct 23 06:22:09 cbipc[225]: IOX runtime init. T=935€
Oct 23 04:26:54 node[213]: cmd = openssl x509 -text -
Oct 23 04:23:19 node[213]: Exists: true
Oct 23 04:16:58 node[213]: Exists: true
Oct 23 04:14:53 node[213]: Exists: true
Oct 23 03:48:42 node[213]: Exists: true
Oct 23 03:47:39 node[213]: Exists: true
Oct 23 03:47:27 node[213]: Looper timed out sessionz-
Oct 22 10:44:24 systemd[1]: Started Cleanup of Tempor
Oct 22 10:44:24 systemd[1]: systemd-tmpfiles-clean.se
Oct 22 10:44:24 systemd-tmpfiles[6579]: /etc/tmpfiles
Oct 22 10:44:24 systemd[1]: Starting Cleanup of Tempc
Oct 21 10:44:00 systemd[1]: Started Cleanup of Tempor
Oct 21 10:44:00 systemd[1]: systemd-tmpfiles-clean.se
Oct 21 10:44:00 systemd-tmpfiles[5926]: /etc/tmpfiles
Oct 21 10:44:00 systemd[1]: Starting Cleanup of Tempc
Oct 20 10:43:19 systemd[1]: Started Cleanup of Tempor
```

### OPEN-SOURCE ACKNOWLEDGMENT NOTICES

Some components of the software used in FBXi are distributed under one or more 3<sup>rd</sup>-party and open-source licenses. The licenses are listed on the [Diagnostic > Acknowledgements](#) page.

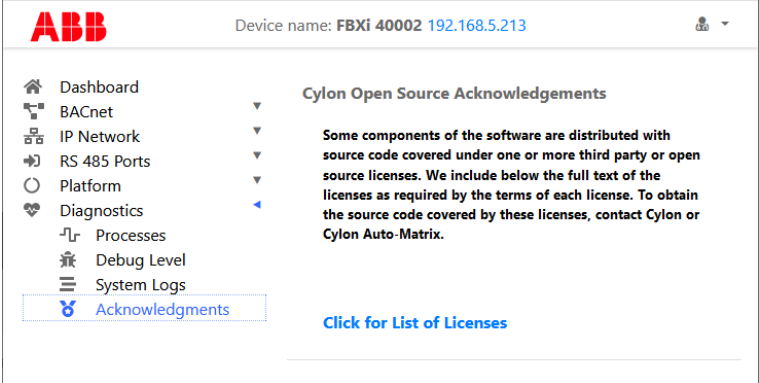

## 5 Installation

### APPLY POWER TO THE FBXi-X256

For the initial configuration of the device, the controller must first be powered on.

**Note:** Service Port (USB connection) must not be connected until after the device is powered on.

The FBXi-256 requires 24 V AC/DC supplied from an externally mounted power transformer. One conductor of the transformer must be grounded to an earth ground to avoid damage to the controller. This conductor will be wired to the COM (common) terminal of the controller. The wiring diagram is shown here:

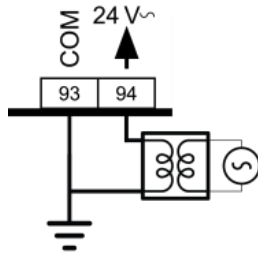

**Note:** Ensure the 24 V AC/DC and Common wires are correctly connected to the controller. If the wires are swapped, it may cause damage to anything connected to the controller.

### CONNECT THE FBXi TO AN IP NETWORK

Place an Ethernet cable from the Network's Ethernet switch into one of the 2 Ethernet ports on the top of the FBXi:

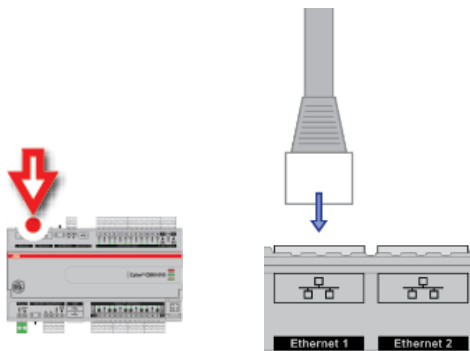

#### IP Cabling requirements

Cable	Standard patch cable, Cat 5e with 4 pairs of wires fitted with RJ-45 connectors
RJ-45 pin connections	Straight-through wiring
Characteristic impedance	100-130 Ohms
Distributed capacitance	Less than 100 pF per meter (30 pF per foot)
Maximum Cable length between IP devices	328 ft. (100 m) maximum

## THE FBXi INTEGRATED ETHERNET SWITCH

The FBXi-X256 includes an integrated Ethernet Switch, with 2 ports. This allows the device to forward IP packets from each port to the other, allowing FBXi and CBXi devices to be connected in a Daisy-Chain topology:

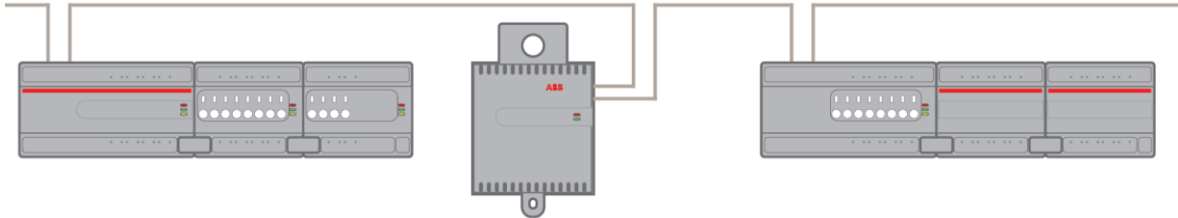

It is recommended that both ends of an FBXi / FBVi / CBXi daisy chain network are connected to a single switch that supports the Spanning Tree network switch protocol (STP). In this scenario a single line break or controller failure in the loop will allow all controllers to continue to communicate.

For example, if controllers A, B, C, D and E are daisy-chained, connected on both sides, with a single switch supporting Spanning Tree Protocol:

- If controller B loses power, controller A will be on one trunk, and C / D / E will be on another all communicating.
- If controllers B and D lose power, controllers A and E will communicate, but controller C will not.

**Note:** The FBVi Series controller has a pass-through across its IP switches, such that if it loses power controllers ‘downstream’ will continue to be connected. Only the FBVi Series has this feature.

**Note:** If you plug both ends of the daisy chain network into a switch that does not support the Spanning Tree Protocol, it will flood the network with requests. The switch will send and receive the same messages over and over again, until something breaks.

## CONFIGURING THE IP CONNECTION

Configuring the IP connection using CXpro<sup>HD</sup>

CXpro<sup>HD</sup> includes a utility to quickly configure BACnet properties for IP devices. To launch this utility, right-click on a Site in the Site List and select Configure IP BACnet Device Properties

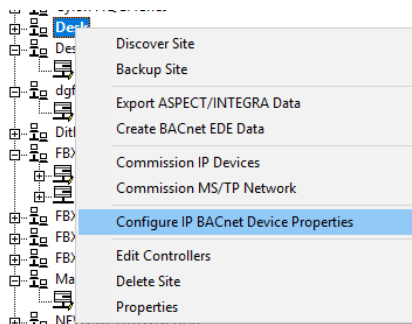

The utility will scan for all CBXi, FBXi and FBVi devices on the selected network.

**Note:** The devices must be configured within CXpro<sup>HD</sup> before they can be accessed by this utility.

When scanning is complete, the Associate IP Devices dialog will open:

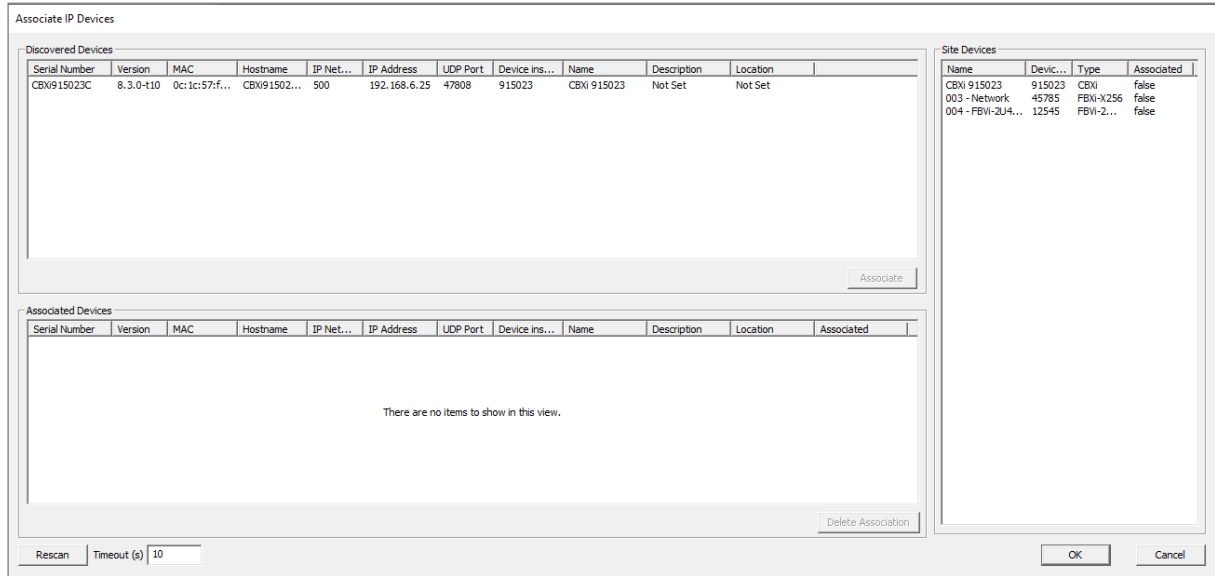

The **Site Devices** panel on the right lists all of the relevant IP devices configured in the CXpro<sup>HD</sup> Site that have been successfully discovered on the BACnet network.

The **Discovered Devices** panel on the top left lists all of the relevant devices that have been discovered on the network

The **Associated Devices** panel on the bottom left lists any Discovered Device that has been associated with a configured Site Device.

### How to Associate devices

To associate a Discovered Device with a Site Device, select a device in the **Site Devices** list and a device in the **Discovered Devices** list and click the **Associate** button. Alternatively, you can drag the Site Device and drop it over a Discovered Device.

Once this is done, the discovered device is moved to the **Associated Devices** list. The device on the Site PC is updated with the Device Instance of the physical devices.

The MAC address will be stored in the site configuration as the key, so associations are maintained if the tool is run again.

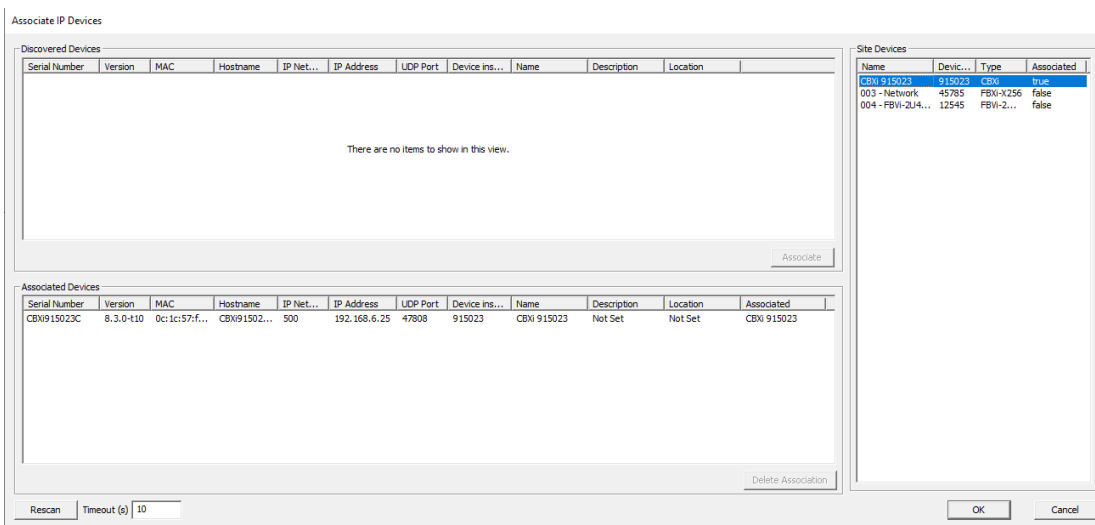



When all required devices have been associated, click **OK** to open the **Configure IP device** dialog where the IP Properties of Associated devices can be edited.

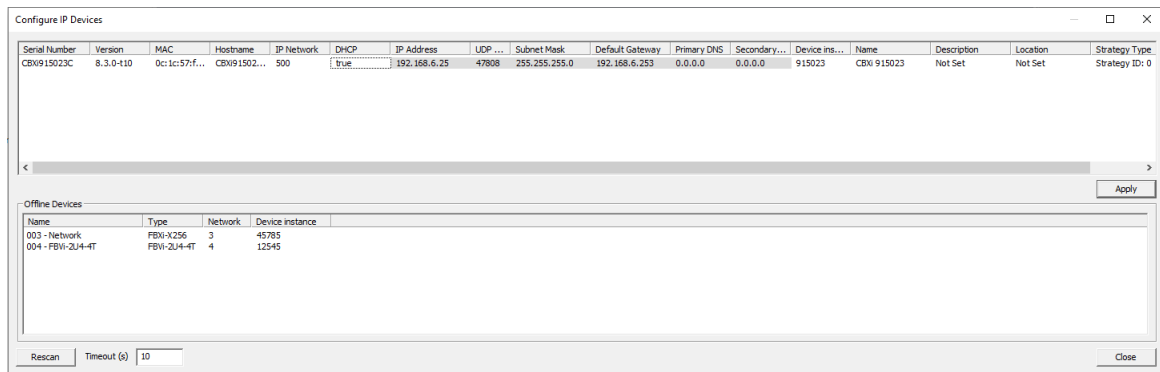

The list on the bottom shows the unassociated or offline devices.

When the properties are set as required, click **Apply** to send the changes to that controller.

## Configuring the IP connection without CXpro<sup>HD</sup>

If your network does not have a DHCP server, then the **FBXi** controller will use a default IP address, which is made up as follows:

- The first byte of the IP address is set to 10
- The 6 digits of the numerical part of the serial number grouped into 3 sets of 2 digits to form the last 3 bytes of the IP address.

For example, a **FBXi** with serial number **901001A** will be allocated the default IP address of **10.90.10.01**



**Note:** For a laptop (or PC) to communicate with a **FBXi** configured in this way, the IP address of the laptop's Ethernet port must be set to a subnet that is compatible with the **FBXi**'s IP address.

For example, if the **FBXi** has an IP address of **10.90.10.01**, the laptop could have an address something like **10.90.10.nn** with a subnet mask of **255.255.255.0**.

**Note:** If the default IP address is used on a network, it can cause an IP Address conflict if the network's subnet mask is **10.0.0.0/8** (see *Subnetwork (Subnet)* on page 8).

It may be possible to reach the **FBXi** over the network but BACnet messaging may fail.

In this case you may need to use a directly-connected laptop, or a different network to configure the **FBXi**. Alternatively you could change the **FBXi**'s subnet mask to **10.ss.ss.ss/24**, (where *ss* is the serial number) to reduce the size of the subnet that could give rise to conflicts. For example, a **FBXi** with serial number **901001A** should have a subnet mask of **10.90.10.01/24**.

### Accessing the FBXi's Web UI

Point a web browser at the FBXi device's IP address, and log in to the Web UI.

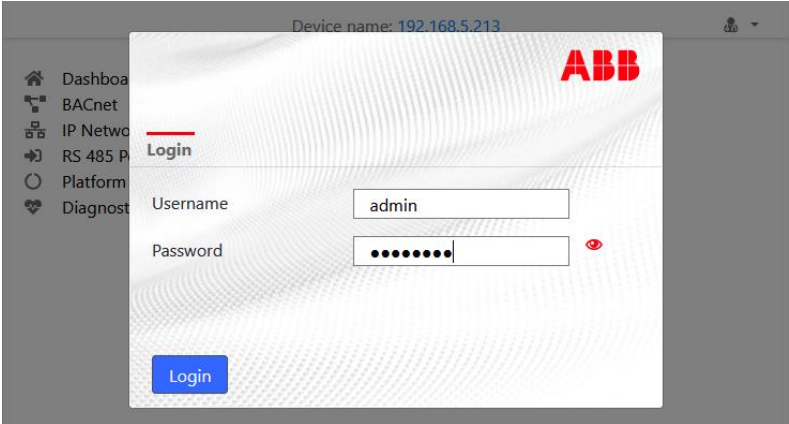

**Note:** By default, all FBXi devices leaving the factory are configured with the following login:  
username: admin  
password: cylonctl

It is recommended that you change these credentials by clicking on the User icon in the top-right of the Web UI page and selecting Change Password.

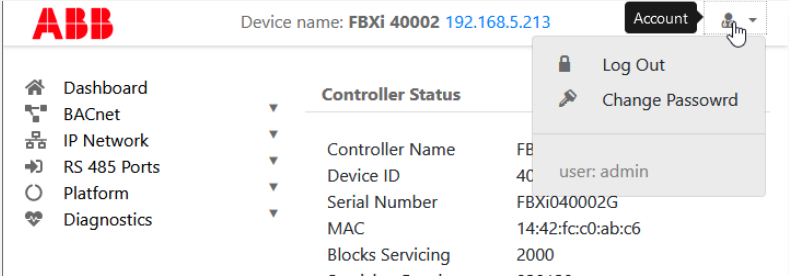

### Configuring IP Ports and IP security

Specify the Ports for each protocol that the device will use, on the **IP Network > TCP/UDP Ports** page:

The screenshot shows the ABB web interface for configuring IP Network TCP/UDP Ports. The page title is "IP Network TCP/UDP Ports". Below the title, there is a paragraph of text: "IP Network TCP and UDP ports are ports open to the outside world. HTTPS/HTTP are used for this web configuration. HTTPS is always enabled, though the port can be changed if required. HTTP is disabled by default. The BACnet ports are needed if the controller must communicate with other BACnet controllers over IP." Below this text is a table with three columns: "Protocol", "Enabled", and "Number". The table contains four rows: "https" (Enabled: checked, Number: 443), "http" (Enabled: checked, Number: 80), "BACnet" (Enabled: checked, Number: 47808), and "BACnet NAT" (Enabled: checked, Number: 47809). At the bottom of the table, there are two buttons: "Cancel" and "Submit".

Protocol	Enabled	Number
https	<input checked="" type="checkbox"/>	443
http	<input checked="" type="checkbox"/>	80
BACnet	<input checked="" type="checkbox"/>	47808
BACnet NAT	<input checked="" type="checkbox"/>	47809

**Note:** BACnet NAT is used for accessing the BACnet device from the Internet, for example in the case of remote supervision. The Port Number set here should match the corresponding settings on the **BACnet > BBMD/NAT** page.

**Warning:** Cylon recommend that controllers should not be exposed on the Internet without a VPN. See *HT0038 Aspect, FBXi and CBXi System Network Security Best Practice* for detailed discussion of security issues.



FBXi controllers are shipped with a self-signed certificate. If a new self-signed certificate is required, then one can be created with the form on the **IP Network > Edit SSL Cert** page. If a signed certificate is required, then a signing request can be generated on the **IP Network > Sign SSL Cert** page, based on the information entered on the **IP Network > Edit SSL Cert** page.

The screenshot shows the ABB web interface for editing an SSL certificate. The page title is "Edit SSL Certificate / Request". The left sidebar contains a navigation menu with items: Dashboard, BACnet, IP Network (selected), Configuration, TCP/UDP Ports, Edit SSL Cert. (active), Sign SSL Cert., RS 485 Ports, Platform, and Diagnostics. The main content area has the following elements:

- Header: "Edit SSL Certificate / Request"
- Instruction: "Edit the information inside the SSL certificate."
- List of instructions:
  - For self signed certificates, this replaces the existing certificate. This information will be displayed by a browser when the user requests to view the certificate.
  - For CA signed certificates, this creates the certificate signing request to provide the CA.
- Radio buttons:  Self Signed Certificate,  CA Certificate Request
- Form fields:
  - Common Name:  (Note: "The host/domain name of this controller")
  - Organization:
  - Organization Unit:
  - Country:  (Note: "Two letter country code")
  - State/Province:
  - City/Locality:
- Buttons:  and

The **IP Network > Edit SSL Cert** page allows you to enter the details for an SSL certificate, which can be applied to the current FBXi as a self-signed certificate, or else these details can be used to generate a request for a 3<sup>rd</sup>-party SSL Cert on the **IP Network > Sign SSL Cert** page.

To install a 3<sup>rd</sup>-party SSL Cert, or to generate a request for a 3<sup>rd</sup>-party SSL Cert, use the [IP Network > Sign SSL Cert](#) page:

Device name: **FBXi 40002** 192.168.5.213

- Dashboard
- BACnet
- IP Network
  - Configuration
  - TCP/UDP Ports
  - Edit SSL Cert.
  - Sign SSL Cert.
- RS 485 Ports
- Platform
- Diagnostics

### Install Signed SSL Certificate

The certificate supplied with the system is self-signed. It will properly encrypt messages to prevent another party from viewing the information being transferred. However, it will not prove that the device is who it claims to be. This causes browsers to display a security warning when accessing the site.

Having the certificate properly signed by a trusted CA will avoid this warning. To do this:

- Use the Edit Certificate menu selection to insure that the identification information is proper.
- Download the certificate signing request.
- Have the request signed by the CA.
- Upload the signed certificate.

#### Download Certificate Signing Request

The downloaded request (.csr) will include your identification information as entered in the Edit SSL Certificate screen.

The Common Name in the certificate must match the FQDN of this controller. I.E.: `thiscontroller.yourcompany.com`

Download

#### Install Signed Certificate

The file to be installed is a .PEM text file. The file consists of the signed server certificate followed by the intermediate certificate used to sign it.

Install

## CONFIGURE THE FBXi-X256 FOR BACNET® COMMUNICATIONS

The FBXi can act as an MS/TP router, passing BACnet comms to devices that are attached to its serial port.

In order for this to happen, the port must be configured for MS/TP Comms using the **RS 485 Port > Configuration** page in the FBXi's web UI:

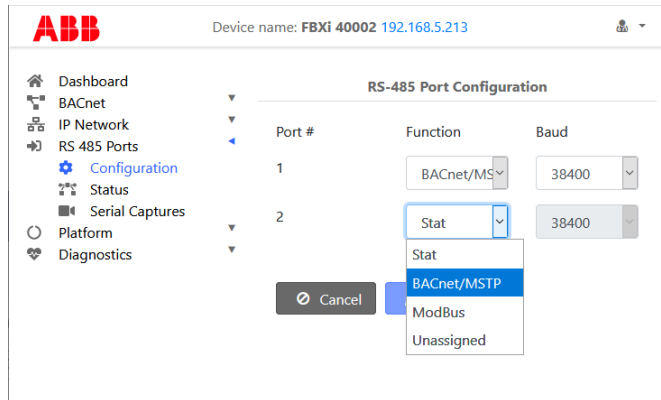

and, if necessary, on the **IP Network > TCP/UDP Ports** page:

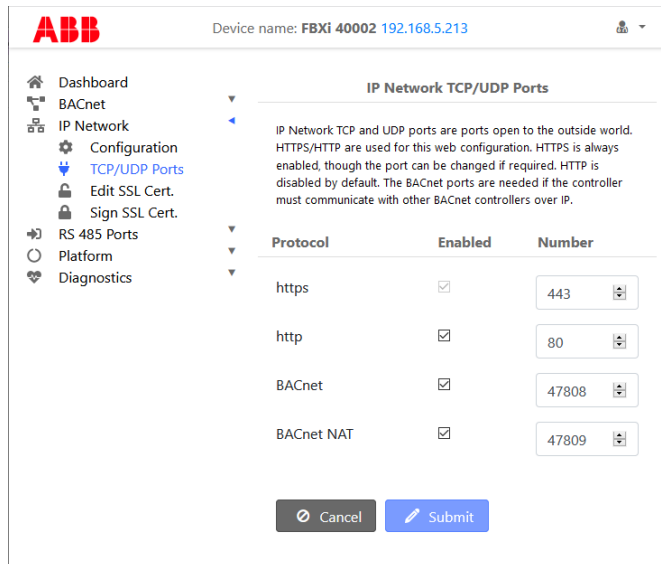

Set the **Device ID** in the **BACnet > Device** page, and optionally set a **Device Name**:

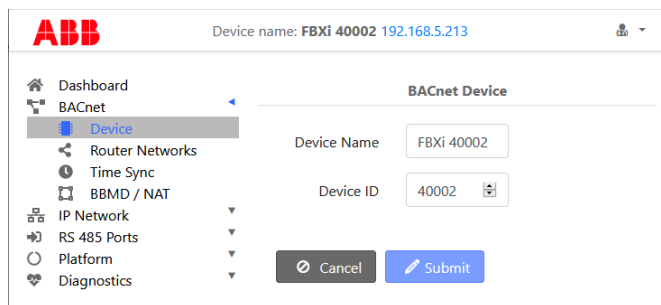

**Note:** Device ID is the BACnet device instance number. Every BACnet controller within the site must receive a unique BACnet instance number to ensure proper communications. This BACnet instance number should be unique even across subnets. By default, it is set to the entire numeric portion of the Controller's serial number.

If the FBXi device is to act as a BBMD (allowing BACnet communication between Ethernet subnets), enter the relevant parameters on the BBMD/NAT page: (see *BACnet IP*

*BACnet/IP uses the User Datagram Protocol (UDP) to send data packets. ASHRAE adopted BACnet/IP in annex j of the 135- 1995 standard.*

BACnet/IP communicates using four methods.

- BACnet/IP to BACnet/IP (same subnet): Assuming that two devices know each other's IP addresses and the UDP ports they are using, i.e., their respective B/IP addresses, there is nothing that restricts them from communicating directly.
- BACnet/IP to BACnet/IP (different subnet): The location of the two devices is already known by the host and the message is routed to the device using switches and routers.
- Broadcast (same subnet): This is a standard Who is/ I am message sent across a local subnet for the BBMD to discover what the address are for the BACnet devices on the subnet.
- Broadcast (different subnet): This is a standard Who is/ I am message sent across a local subnet for the BBMD to discover what the address are for the BACnet devices on other subnets.

BACnet IP Broadcast Management Device (BBMD) on page 17 for more detail)

Device name: FBXi 40002 192.168.5.213

### BACnet BBMD / NAT

When this device is behind a NAT gateway, the NAT configuration is enabled to allow external BACnet devices/tools to route to the internal network.

NAT Routing

Enabled

External IP Address: 192.168.1.1

UDP Port: 47809

BACnet Network: 504

The peer lists allows this device to find BACnet routers on non local networks. The preferred configuration is to a BBMD enabled router on the remote networks. In this setup, the IP is the remote BBMD and the netmask is 255.255.255.255

BBMD Peer IPs	Peer UDP Port	Netmask	
			+

NAT Peer IPs	Peer UDP Port	Netmask	
			+

Cancel Submit

**Note:** The MS/TP baud rate must match on all devices on the MS/TP subnet. For the FBXi this is set in the RS485 Port > Configuration page (see page 28)

Device name: FBXi 40002 192.168.5.213

### RS-485 Port Configuration

Port #	Function	Baud
1	BACnet/MS	38400
2	Stat	38400

Cancel

**Note:** An FBXi cannot have both BACnet MS/TP trunk and a Modbus RTU trunk simultaneously, but an FBXi controller that has an MS/TP subnet can read and write points to Modbus devices over IP.



## CONNECT THE FBXi TO BACNET MS/TP

If the FBXi unit will be used with a BACnet MS/TP fieldbus, connect it as described in the following section.

### MS/TP Cabling Requirements

**Note:** Use Copper or Copper Clad Aluminum 70 °C conductors only.

Terminals	PCB mounted plug terminal connections
Conductor Area	Max: AWG 12 (3.31 mm <sup>2</sup> ) Min: AWG 22 (0.355 mm <sup>2</sup> )
Max cable length	1.2 km @ 38K4 baud

### TERMINATE THE MS/TP NETWORK

If the FBXi-X256 is the first or last device on the RS-485 network, then its MS/TP subnet terminator switch must be set to “in” 

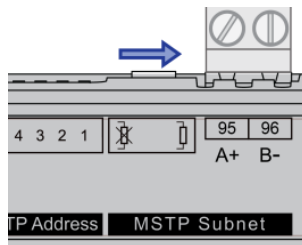

### ATTACH RS-485 COMMUNICATION WIRES TO THE MS/TP SUBNET PORT

Wiring the RS-485 network involves connecting the A+ (95) and B- (96) terminals in a daisy-chained configuration. One end of the network will be connected to the Fieldbus of the Network-level controller or BACnet® router. At the other end of the network, the last device must be “terminated” by either installing a 100 Ω ... 120 Ω resistor or, if the last device is a FBXi, users can switch the MS/TP Subnet terminator switch (located beside the MS/TP port) towards the  icon. This will effectively terminate the network.

The shield (screen) must be carried through the entire network, and must be grounded at one point on the network as shown below:

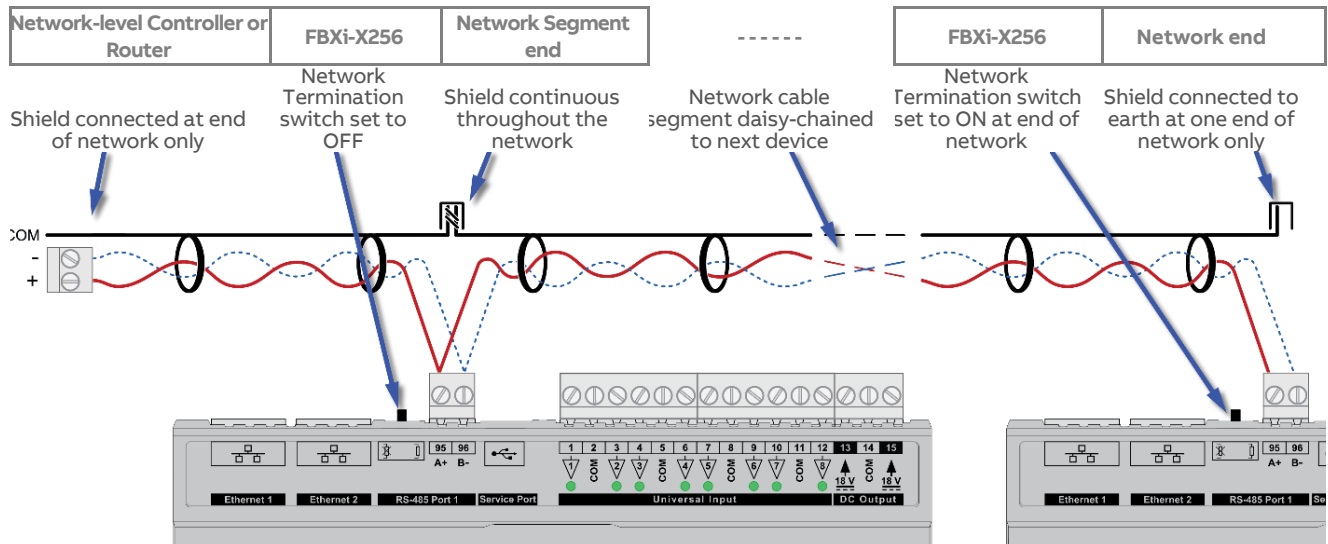

**Note:** If the RS-485 network is wired to an eSC, then the shield will be grounded at the eSC.

## CONNECT THE FBXi-X256 TO FLX UNITS

The I/O capabilities of a FBXi-X256 can be extended by the addition of FLX-8R8 and FLX-8R8-H devices.

These are connected to the FBXi-X256 by means of a standard module interconnector (FLX bus connector), one of which is shipped with each FLX device.

## SET THE FLX ADDRESS

Each of the FLX units connected to a single FBXi must have an address that is unique on that FBXi's FLX bus. The address is set by the 5-way DIP switch.

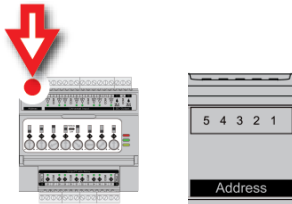

The terminals on a FLX unit will be accessible within the FBXi Strategy with point numbers prefixed by this address as illustrated below:

Inter-module bus Address	DIP switch setting	Point numbers
00000 0		1 ... 16
00001 1		101 ... 116
00010 2		201 ... 216
00011 3		301 ... 316
01111 15		1501 ... 1516

**Note:** If there are 2 devices on the same FLX bus with the same address – including 0, the address of the FBXi - then the bottom (yellow) status LED will blink slowly to indicate a FLX bus address clash.

**Note:** FLX addresses must be consecutive, starting at 0.

### JOIN OR TERMINATE THE FLX BUS

Place the devices side-by-side and place the FLX bus connector into the two adjacent sockets at once.

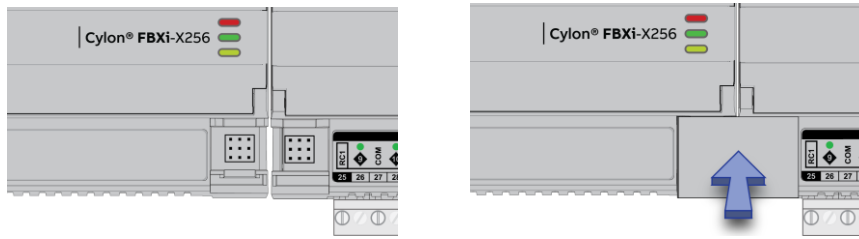

The end device on a FLX bus (either a FLX device or the FBXi itself if no FLX devices are connected) must have a terminator inserted into its interconnector socket. One terminator is shipped with each FBXi-X256 device.

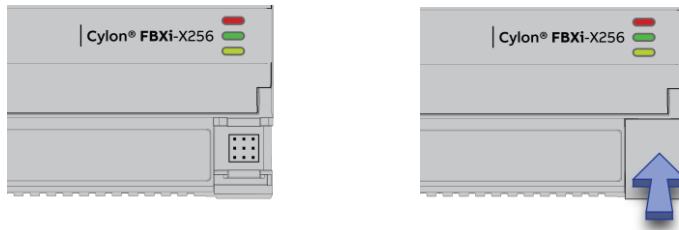

### (IF REQUIRED) SET UP FLX BUS EXTENSION

If a FLX device cannot be located beside a CBXi or FBXi device or another FLX device then the FLX bus can be connected by cable using two FLX-RMC Remote Module Connectors, sold separately.

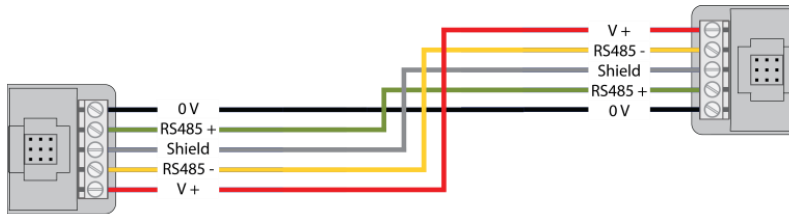

Connect cables to the two supplied FLX-RMC screw-terminal connectors as shown above with the appropriate length of cable.

**Note:** Use Copper or Copper Clad Aluminum conductors only. Multiple wired connections can be used between FLX modules, but the total FLX bus length must be less than 1200 m (3280 ft) for RS-485 communications.

**Note:** The total length of FLX bus segments powered by one source (FBXi, CBXi, CBXi or FLX-PS24) must not exceed the following lengths:

Cable gauge	Max length
AWG 18	30 m / 100 ft.
AWG 22	15 m / 50 ft.

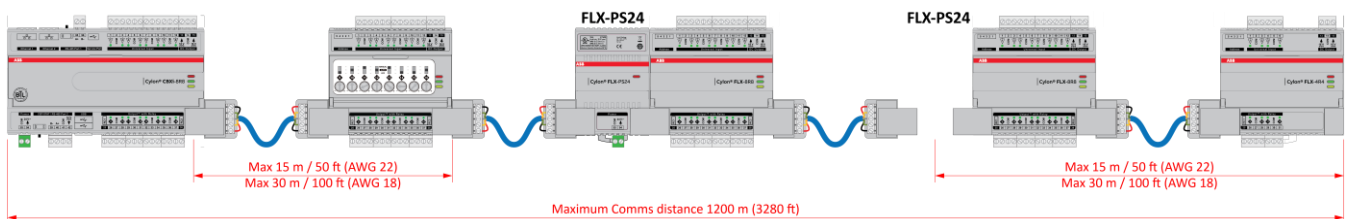

If the RMC is connected to the Left-Hand side of a FLX-PS24, then it is not strictly necessary to connect the 0 V and V+ lines:

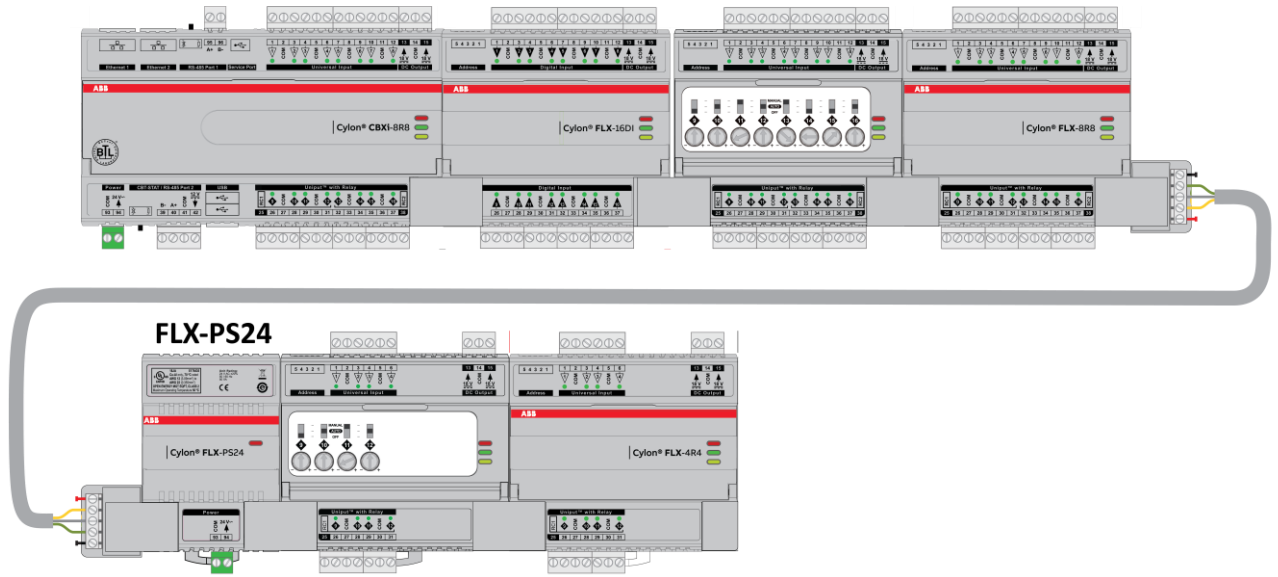

## Attaching RMC terminals

Remove the Interconnect (if installed) from the right-hand side of the FLX, FBXi, CBXi or CBX where the RMC is to be installed.

Slide one RMC connector into the T-slot of the CBX or FLX at the point at which the BUS is to be extended.

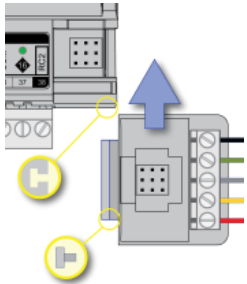

## Replace the Interconnect

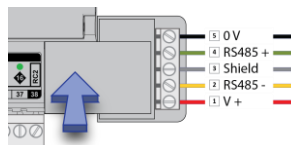
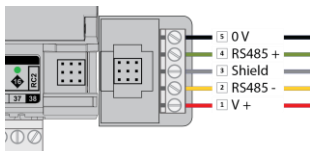

Slide the other RMC connector into the Left-Hand T-slot of the remote FLX.

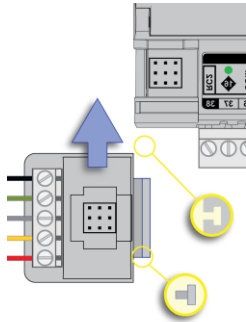

Insert the second interconnect



**Note** The termination block can only be used on the **right-hand** interlink connector of the last **FLX** unit on the FLX bus.  
While it is possible, in a multi-tier system, to connect intermediate tiers from right to left to ease installation, the final tier **must** be wired from left to right so that the FLX bus can be terminated on the RHS connector of the last **FLX** on the bus

## ADD THE CONTROLLER TO THE CXpro<sup>HD</sup> SITE

### SET CONTROLLER DATE AND TIME

Use the FBXi web UI (Platform > Set Time and Date) to set the controller's clock.

Alternatively, if a device on the site has been set up as a Time Sync Master, then click the **Enabled** checkbox under NTP Time Service, and the FBXi-X256 controller time will be automatically updated.

The screenshot shows the ABB web UI for a device named 'FBXi 40002 192.168.5.213'. The left sidebar contains navigation options: Dashboard, BACnet, IP Network, RS 485 Ports, Platform (selected), Status, Upgrade Firmware, Backup / Restore, Set Time and Date (highlighted), Restart, and Diagnostics. The main content area is titled 'Platform Set Time and Date' and contains the following sections:

- Platform Set Time and Date:**
  - On most networks, NTP is used to automatically keep time/date. Enabling it generally requires no additional options.
  - Some private networks might have an NTP server that can not be automatically located. If so, check the "Use Custom Server" box and enter the hostname of the NTP server.
  - If NTP is not available, the time can be manually set.
- NTP Time Service:**
  - Enabled:  Synchronized
  - Use Custom Servers:
  - Custom Servers:
- Date and Time:**
  - Date: 2020-10-23 (with edit icon)
  - Use desktop date/time:
  - Time: 08 : 53 : 09 (with up/down arrows for each field)
- Time Zones:**
  - Time Zone: EST5EDT (dropdown menu)

At the bottom, there are 'Cancel' and 'Submit' buttons.

## SET UP THE FBXi AND CONNECTED FLX MODULES IN A SITE IN CXpro<sup>HD</sup>

To add an FBXi to a side, right-click on the Site in the and select **Edit Controllers**:

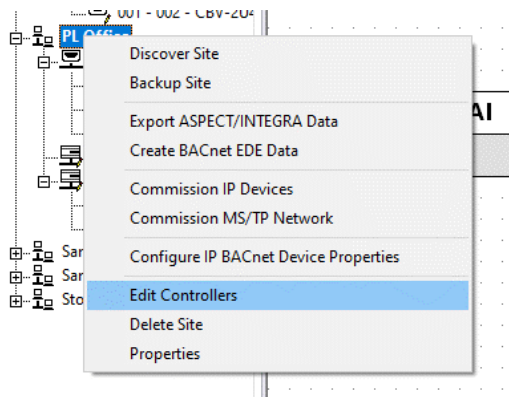

This opens the Edit Controllers dialog:

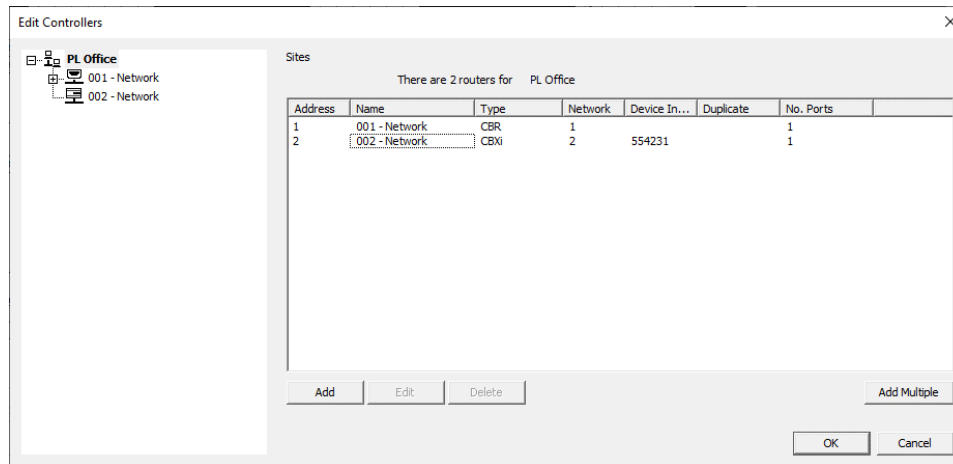

Click the **Add** button and select **FBXi** as the Controller Type in the **New IP Controller / Router** dialog:

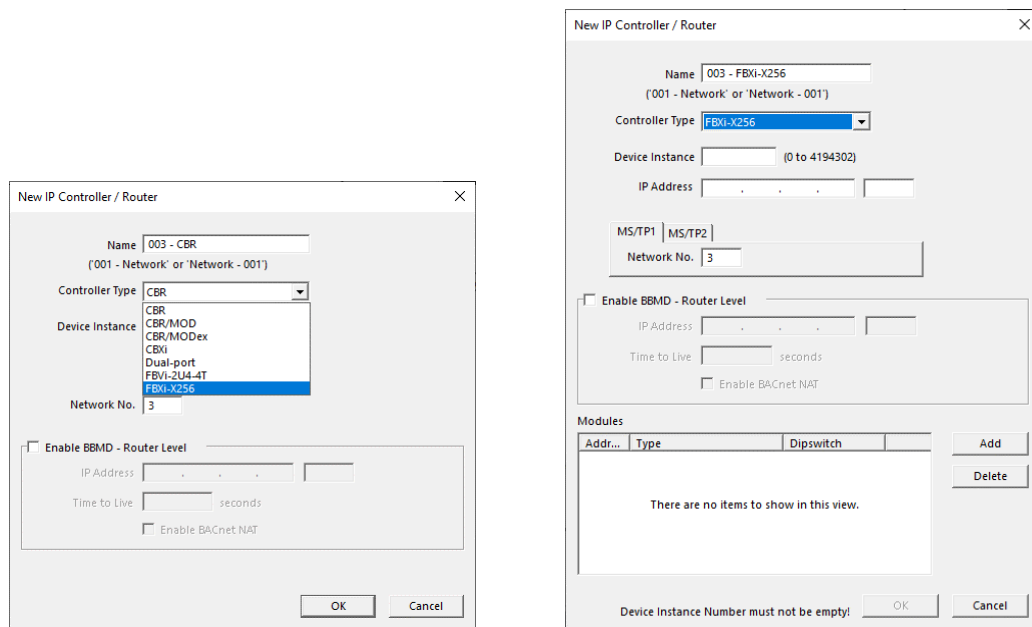

Set the controller **Name**, **Device Instance Number** and **IP Address : Port** (for exporting to ASPECT® and INTEGRA™) and if the **FBXi** device has one or more **FLX** modules connected to it, add the same number of entries in the **Modules** table:

Controller type: FBXi-X256

Device Instance: 554231 (0 to 4194302)

IP Address: 192 . 168 . 85 . 146 | 67

MS/TP1 | MS/TP2

Network No. | 3

Enable BBMD - Router Level

IP Address: . . .

Time to Live: seconds

Enable BACnet NAT

Addr...	Type	Dipswitch
0	FLX-8R8	

Add | Delete

Device Instance Number must be unique! | OK | Cancel

When **FLX** modules have been added, the specific **FLX** type can be set in the **Modules** table **Type** column:

IP Address: . . .

Time to Live: seconds

Enable BACnet NAT

Addr...	Type	Dipswitch
0	FLX-8R8	
1	FLX-8R8	

FLX-8R8  
FLX-8R8-H  
FLX-4R4  
FLX-12C-H  
FLX-16C1

Device Instance Number must be unique! | OK | Cancel

If you attempt to add more modules than the **FBXi** can support, an error message will be displayed:

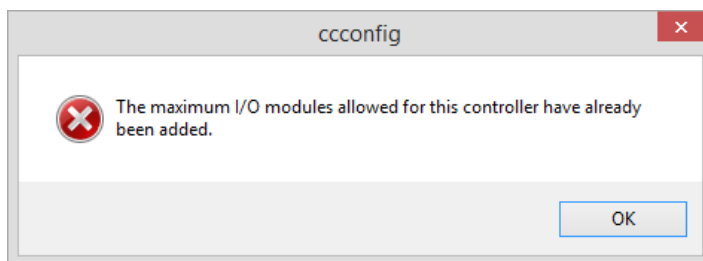

When the correct number of **FLX** modules has been added, click **OK**.

**Note:** The IO module configuration can be changed later by opening the **FLX Module Configuration** dialog from the **Site Tree**:

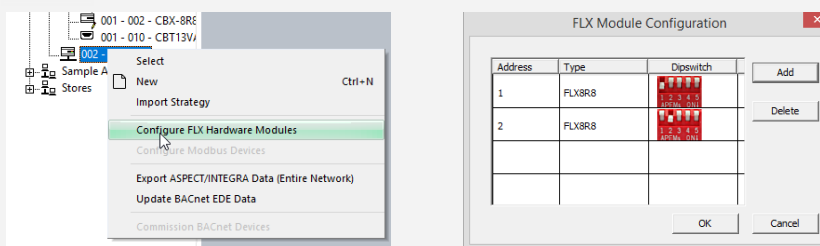



In the Strategy drawing, IO blocks can be added up to the total on the configured FLX modules.

**Note:** If a FLX module is deleted from a FBXi configuration (in CXpro<sup>HD</sup>'s Configuration utility) after the Strategy drawing has been set up, the blocks associated with that FLX's IO will be 'greyed out' to indicate that they are inactive.

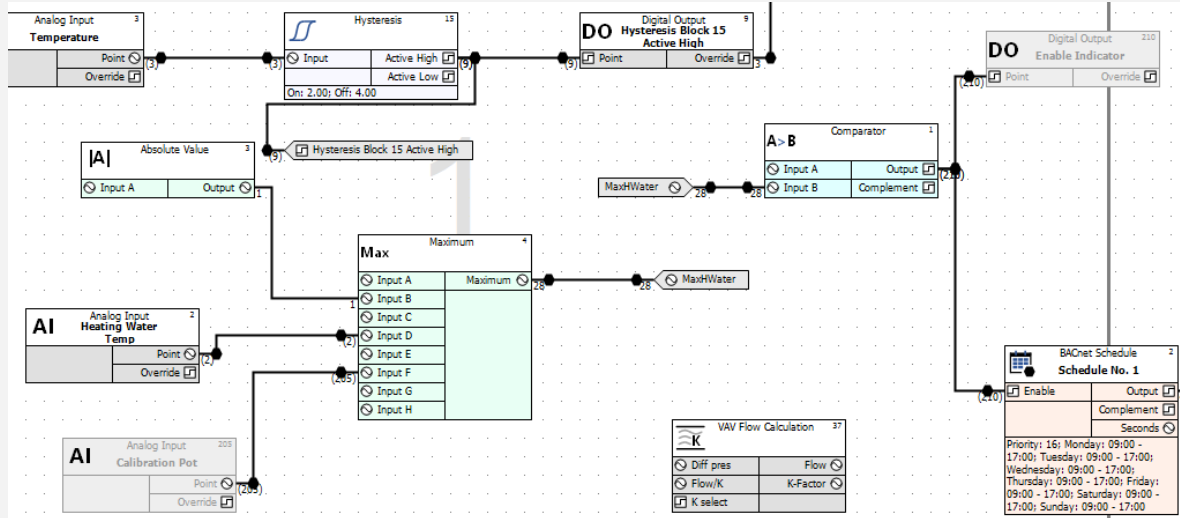

Set the BACnet properties for the new Network, by clicking the BACnet button in the Configuration utility's main menu:

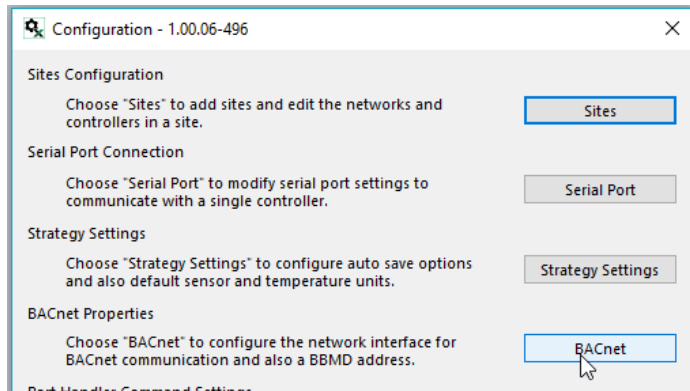

**Note:** If the FBXi needs to communicate with BACnet devices on other IP Subnetworks, enter the IP address of the BBMD device.

Enter a device instance number.

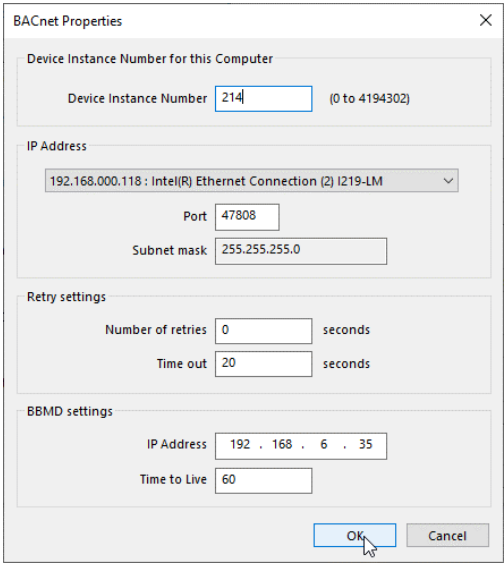

Click **OK**

Reboot the system to apply the new settings:

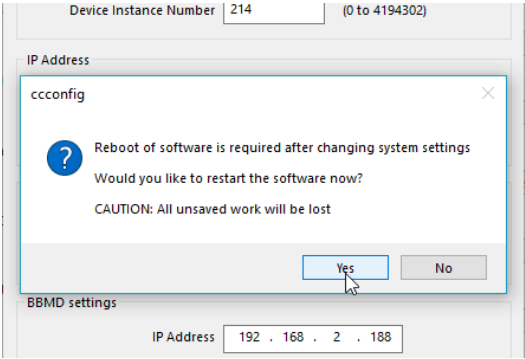

## (IF REQUIRED) CONFIGURE A MODBUS CONNECTION

Modbus connections can be made directly to Modbus IP devices on an RTU trunk connected to the FBXi, or over IP to RTU devices attached to a separate router.

**Note:** An FBXi cannot have both BACnet MS/TP trunk and a Modbus RTU trunk simultaneously, but an FBXi controller that has an MS/TP subnet can read and write points to Modbus devices over IP.

### Configuring a Modbus RTU connection

If a Modbus connection is to be through either of the RS485 Ports,

In the controller's Web UI > RS 485 Port > Configuration page, set Protocol of the required port to Controller Modbus:

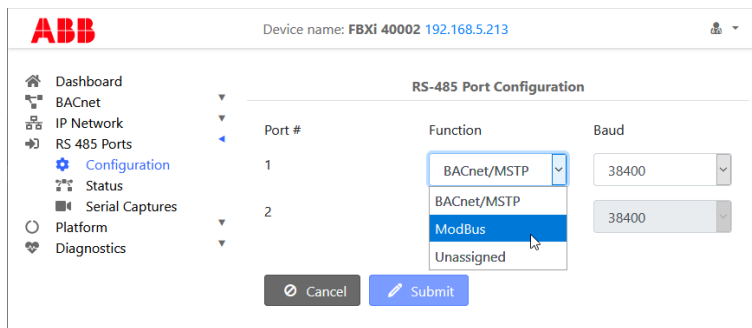

In CXpro<sup>HD</sup>, open the Strategy drawing for the FBXi.

With the Strategy open, right-click on the FBXi in the Site Tree, and select Configure Modbus Devices to open the Modbus Configuration dialog:

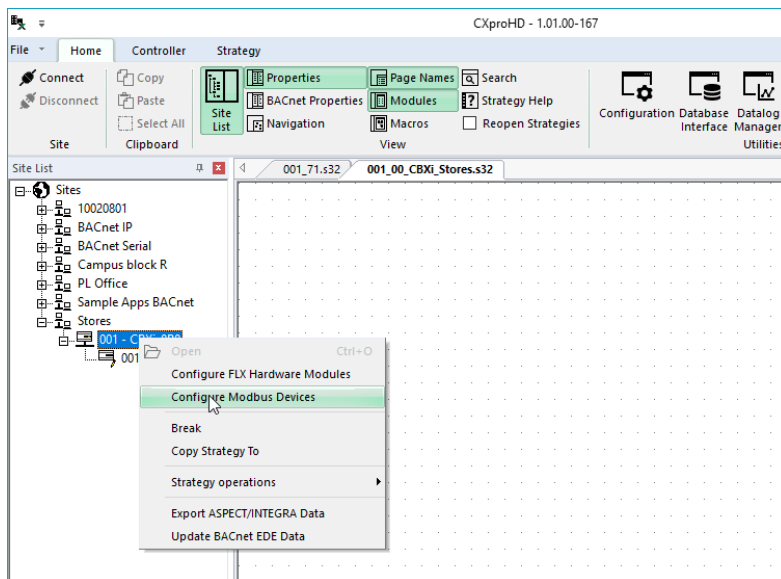

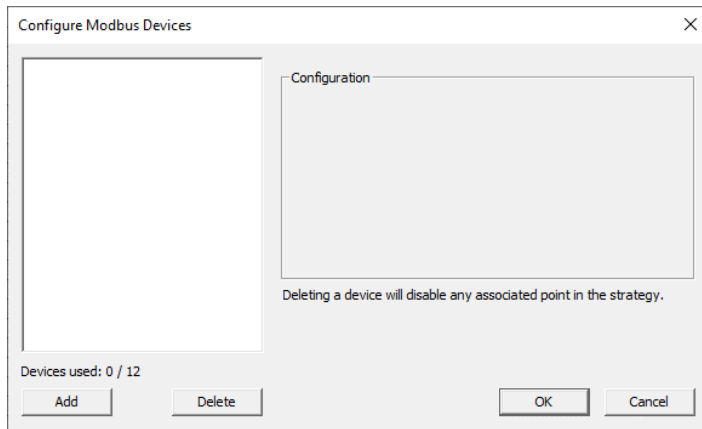

Add a Modbus connection by clicking the **Add** button in the **Configure Modbus Devices** dialog

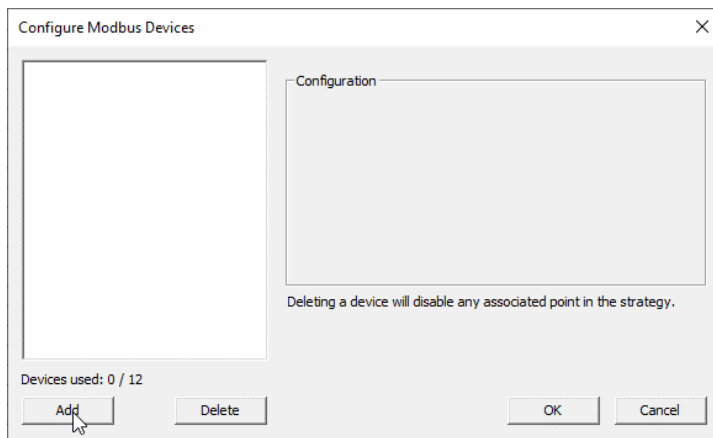

In **FBXi** controllers, each time you add a Modbus device you are offered the choice of adding

1. a Modbus RTU device connected to the FBXi's RTU port
2. a Modbus IP device
3. a Modbus RTU device connected to a separate IP Router

### Connecting directly to a Modbus RTU device

Select **RTU Port** and click **OK**,

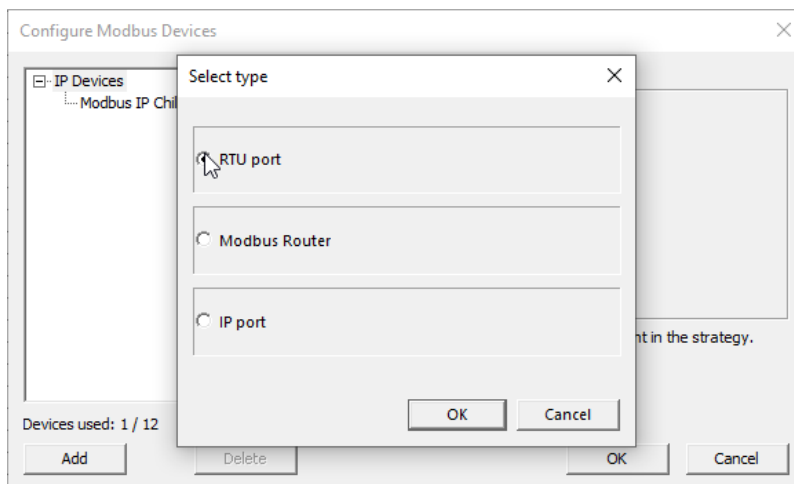

When the first Modbus RTU device is added, an entry for the RTU trunk itself is added. Select this trunk, and set the **Baud rate**, **Parity** and **Stop Bit** to match all other devices on the RS485 trunk:

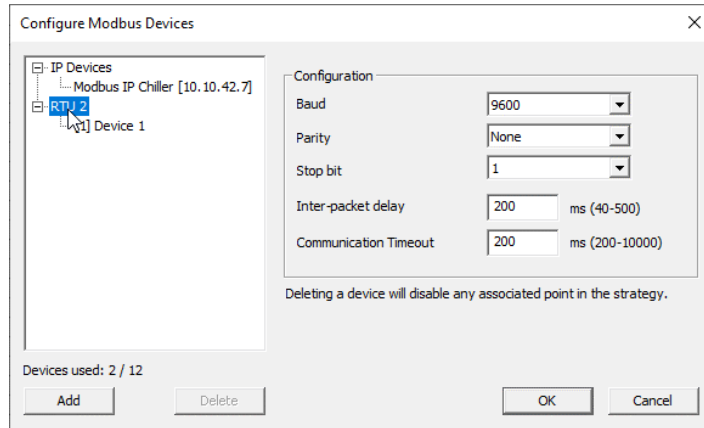

Set a name and Modbus address for the device that was added along with the RTU trunk

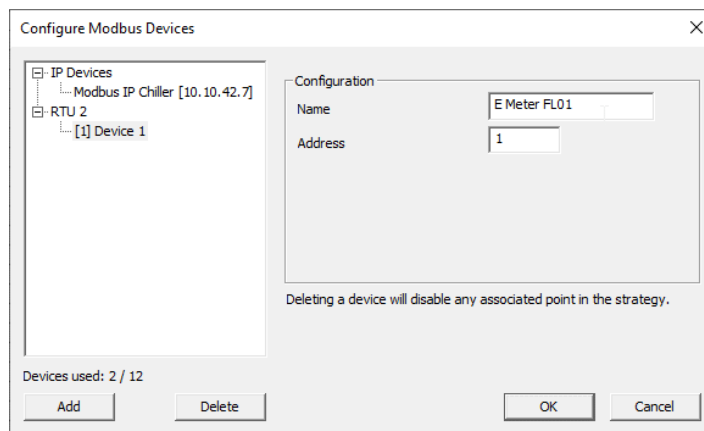

For each additional device on the RTU trunk, click the **Add** button, select **RTU** and specify a name and RTU address.

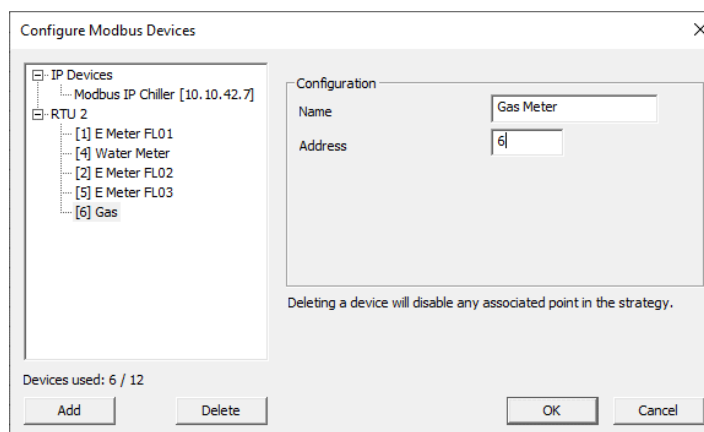

### Configuring a Modbus IP connection

If a Modbus connection is to be over IP,

In CXpro<sup>HD</sup>, open the Strategy drawing for the FBXi.

With the Strategy open, right-click on the FBXi in the Site Tree, and select **Configure Modbus Devices** to open the **Configure Modbus Devices** dialog:

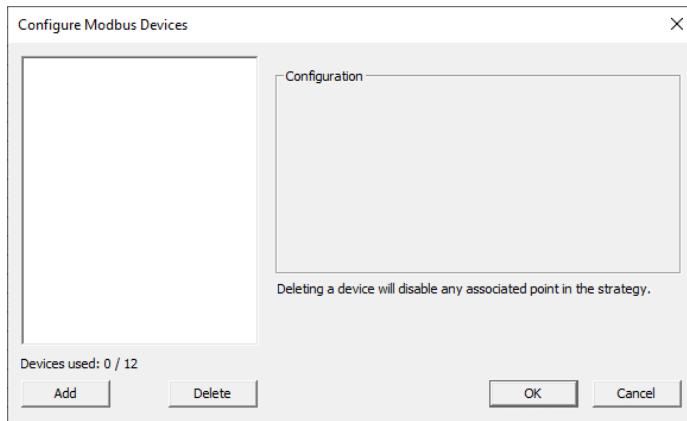
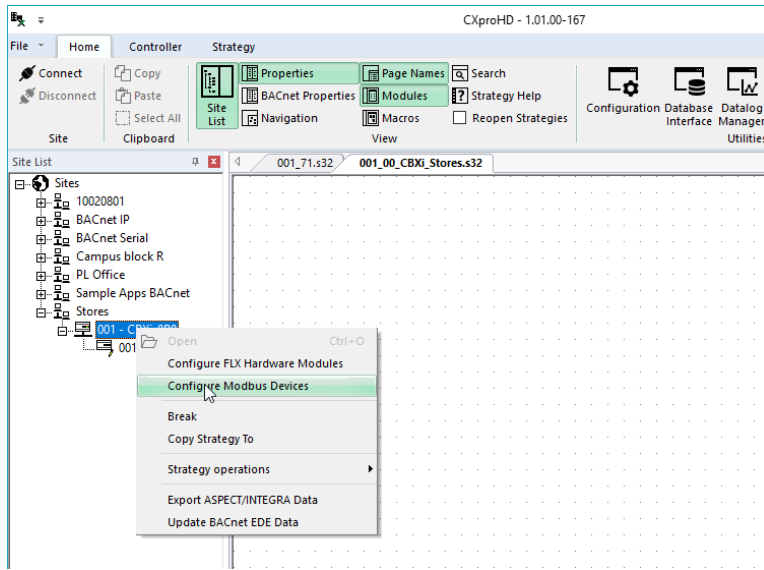

Add a Modbus connection by clicking the **Add** button in the **Configure Modbus Devices** dialog

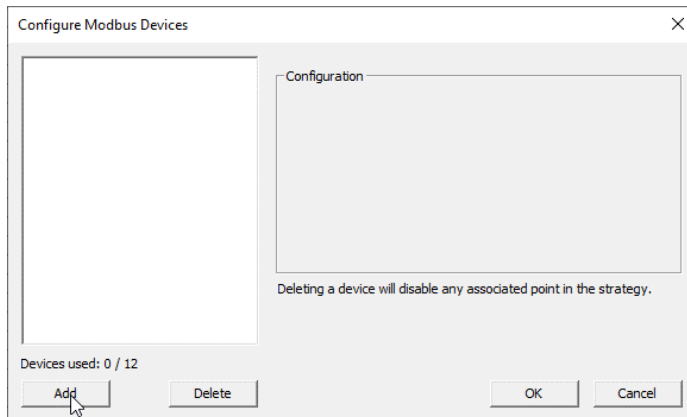

In FBXi controllers, each time you add a Modbus device you are offered the choice of adding

1. a Modbus RTU device connected to the FBXi's RTU port
2. a Modbus IP device
3. a Modbus RTU device connected to a separate IP Router

**Connecting directly to an IP Modbus device**

Select **IP Port** (device directly connected over IP) and click **OK**

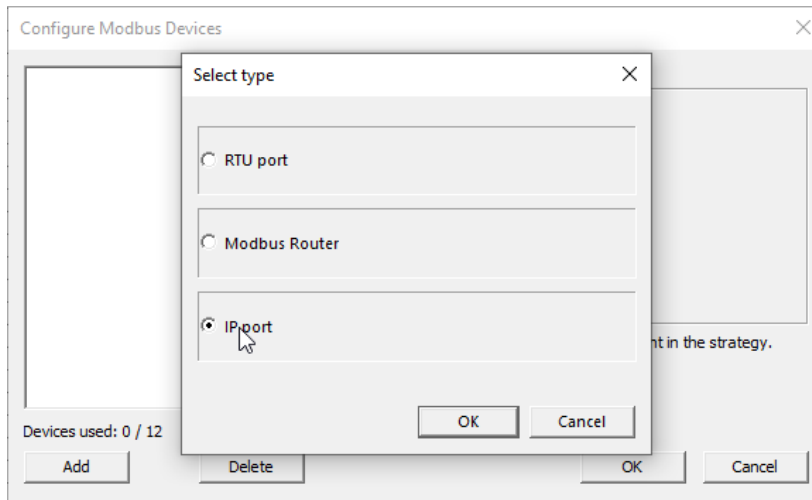

Set the **Name** and **IP Address** for the device and Click **OK**

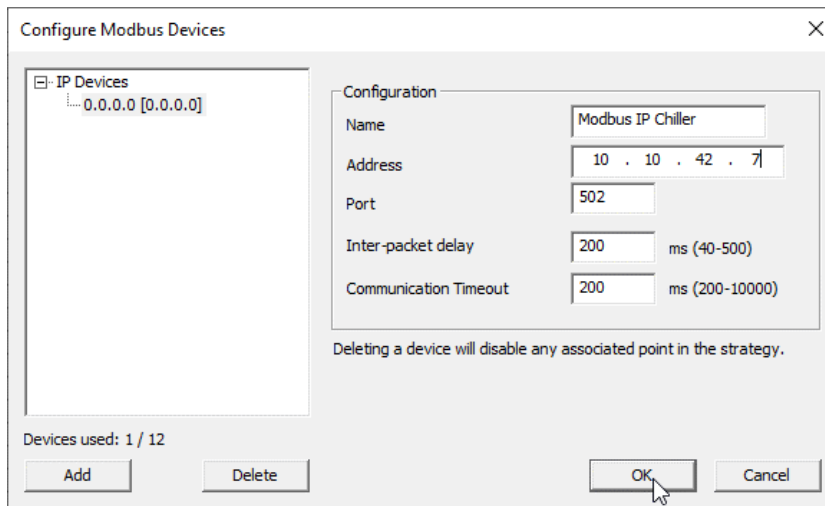

Connecting to a remote Modbus RTU device through an IP router

Select Modbus Router

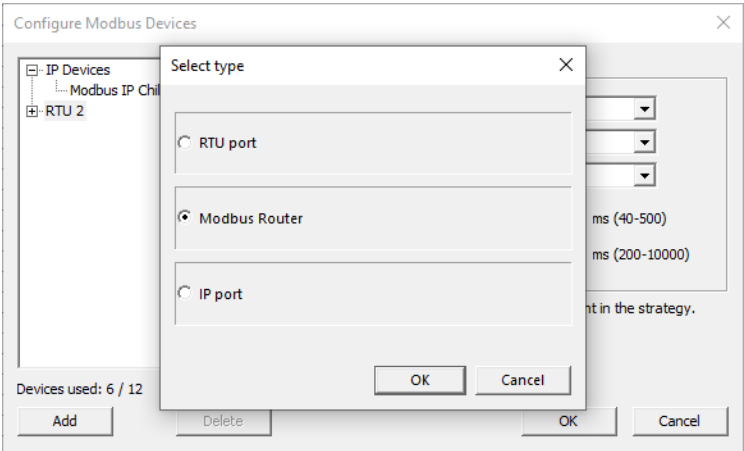

Set a Name, IP address and IP Port for the Router

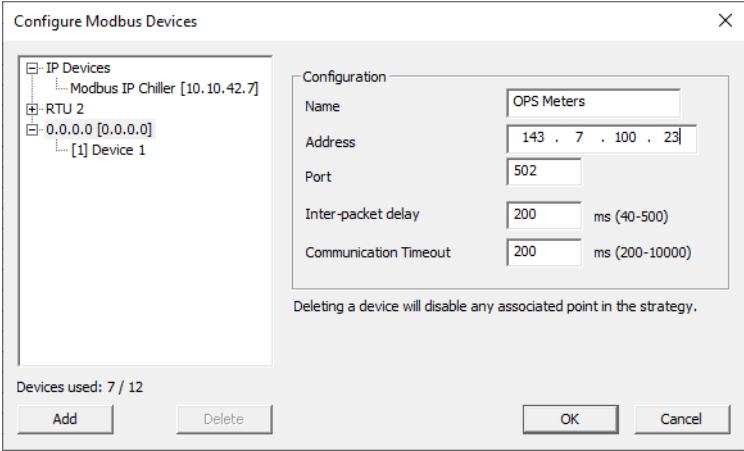

Set a name and Modbus address for the RTU device that was added along with the Router

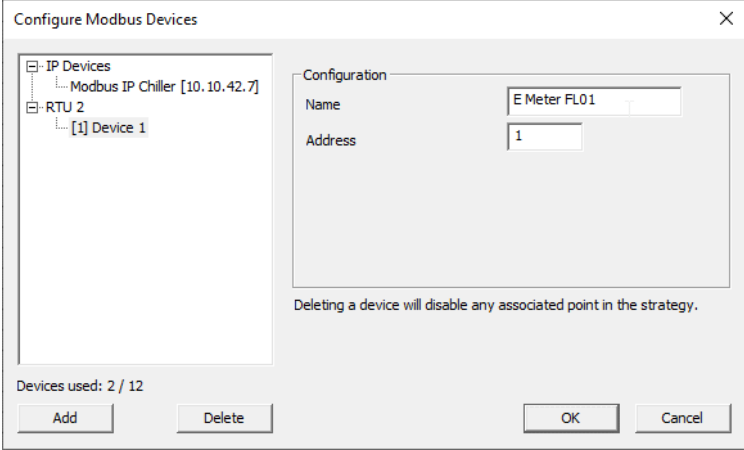



For each additional device on the Router's RTU trunk, click the **Add** button, select **Modbus Router**, select the existing Router in the additional **Select Type** dialog that is displayed:

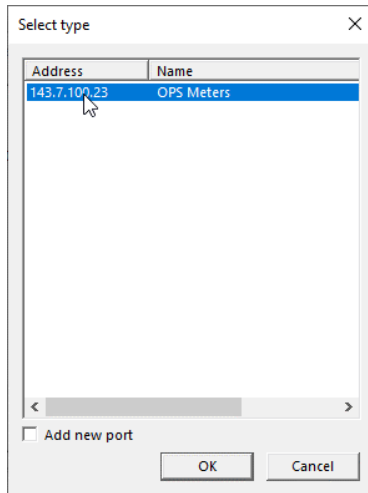

and specify a name and RTU address.

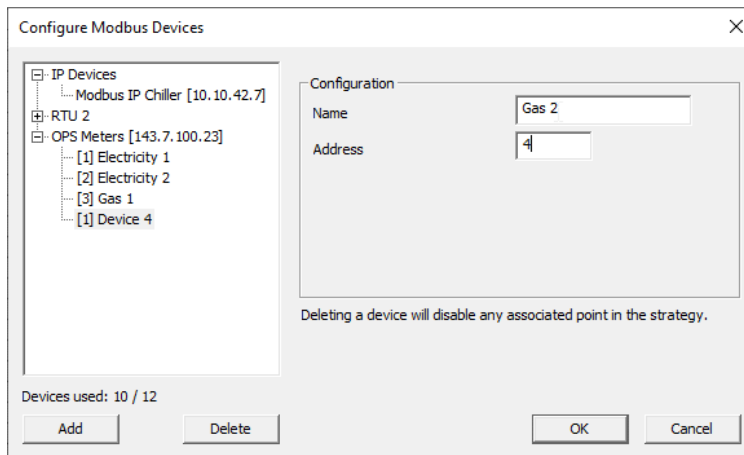

Click **OK** when Modbus device configuration is complete.

## SET I/O TO A KNOWN SAFE MODE

Before connecting equipment to the FBXi-X256 or FLX devices, carry out a **Wipe Controller** command from CXpro<sup>HD</sup> to put I/O into a Known Safe Mode:

- In CXpro<sup>HD</sup> select **Wipe Controller** from the **Controller** tab on the **Ribbon**.  
In the **Wipe Controller** dialog, click in the **'Wipe All'** checkbox.

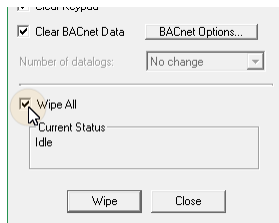

- Click on the **'Wipe'** button.

When the Wipe operation is complete, a **'Controller Wiped'** message is displayed:

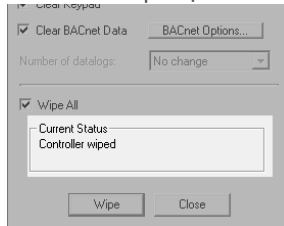

## SET UP THE CONTROLLER STRATEGY

In CXpro<sup>HD</sup>, double-click on the controller in the **Site Tree** to open its Strategy:

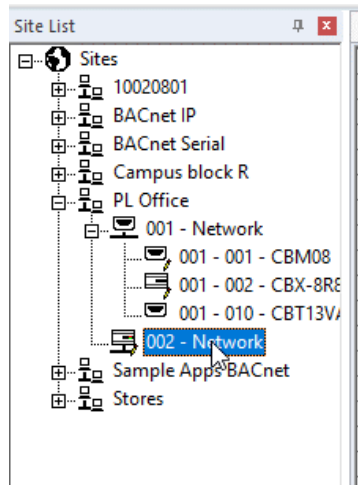

If there is no existing Strategy in the controller, an invitation to create a new one will be displayed:

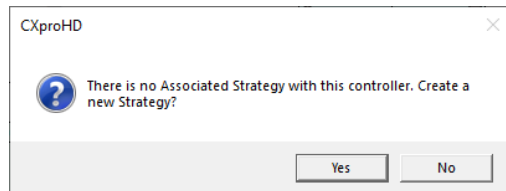

Click **Yes** to open a new blank strategy drawing:

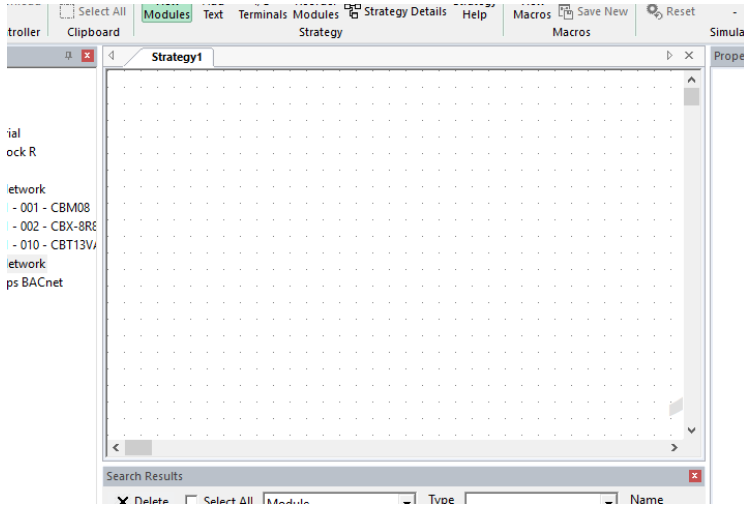

Add strategy blocks and points to create the required strategy – see *MAN0133 CXpro<sup>HD</sup> User Guide* for more detail.

**Note:** In FBXi-X256 controllers there are:

- A total of 2500 strategy blocks, numbered 1 - 2500
- A maximum of 2500 exposed BACnet points
- A minimum of 0 and a maximum of 256 hardware points:
  - The 16 points in an attached FLX with MS/TP address set to “0” are numbered 1 ... 16
  - The 16 points in an attached FLX with MS/TP address set to “1” are numbered 101 ... 116
  - The 16 points in an attached FLX with MS/TP address set to “2” are numbered 201 ... 216
  - The 16 points in an attached FLX with MS/TP address set to “3” are numbered 301 ... 316
  - The 16 points in an attached FLX with MS/TP address set to “4” are numbered 401 ... 416
  - The 16 points in an attached FLX with MS/TP address set to “5” are numbered 501 ... 516
  - The 16 points in an attached FLX with MS/TP address set to “6” are numbered 601 ... 616
  - The 16 points in an attached FLX with MS/TP address set to “7” are numbered 701 ... 716
  - The 16 points in an attached FLX with MS/TP address set to “8” are numbered 801 ... 816
  - The 16 points in an attached FLX with MS/TP address set to “9” are numbered 901 ... 916
  - The 16 points in an attached FLX with MS/TP address set to “10” are numbered 1001 ... 1016
  - The 16 points in an attached FLX with MS/TP address set to “11” are numbered 1101 ... 1116
  - The 16 points in an attached FLX with MS/TP address set to “12” are numbered 1201 ... 1216
  - The 16 points in an attached FLX with MS/TP address set to “13” are numbered 1301 ... 1316
  - The 16 points in an attached FLX with MS/TP address set to “14” are numbered 1401 ... 1416
  - The 16 points in an attached FLX with MS/TP address set to “15” are numbered 1501 ... 1516

**Note:** FLX addresses must be consecutive, starting at 0.

## ACCESSING MODBUS POINTS IN THE STRATEGY

Select Modbus point modules and place them on the strategy drawing area:

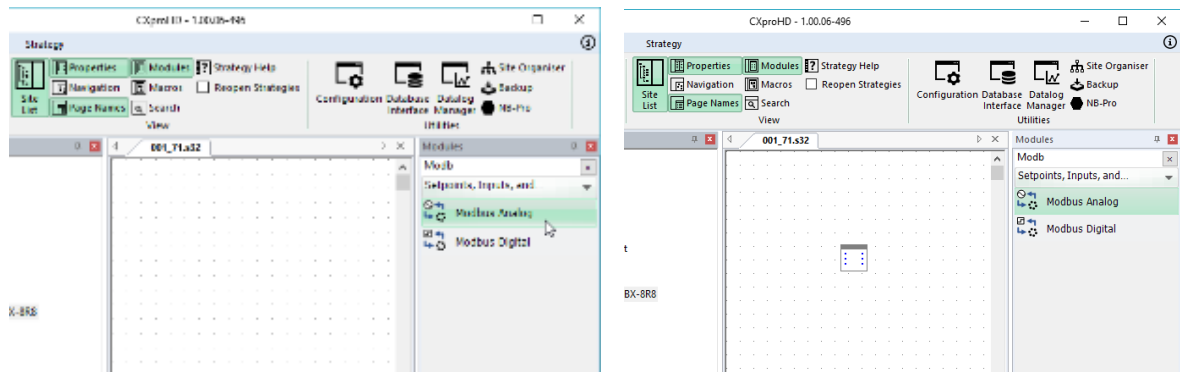

Select the Module Device to which each module will refer, specify the Data Format and Register to use:

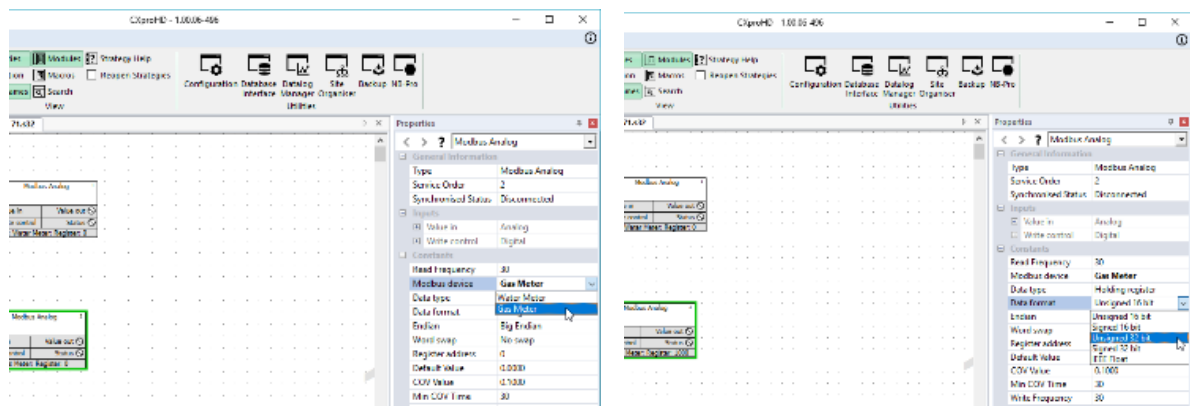

The Modbus point can be read and passed to points in the Strategy:

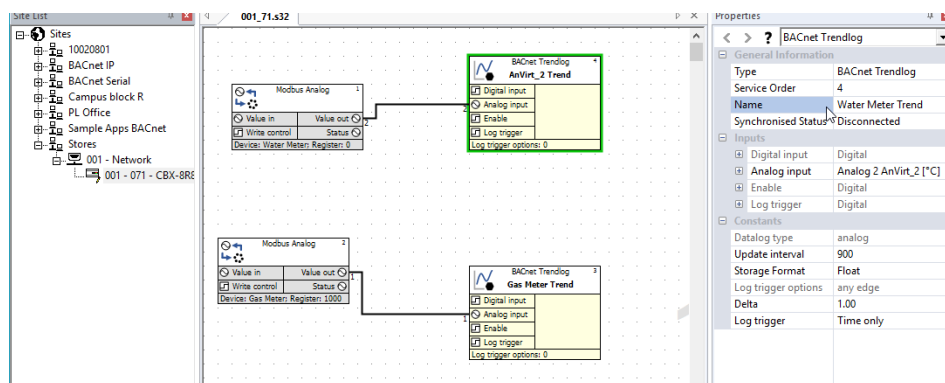

or point values can be passed to the Modbus device by specifying the Coil/Input address:

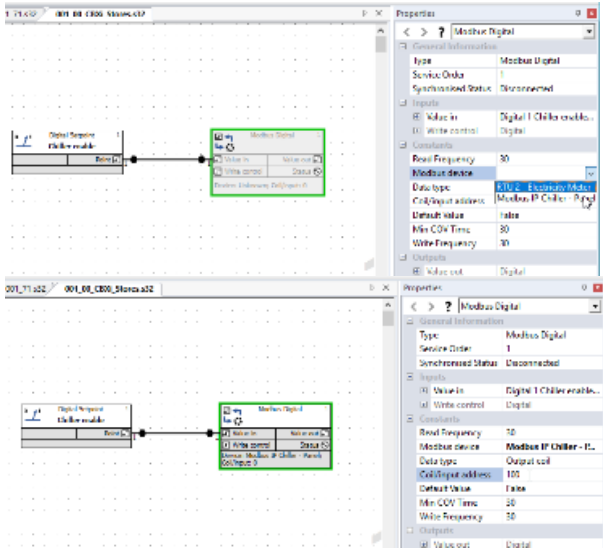





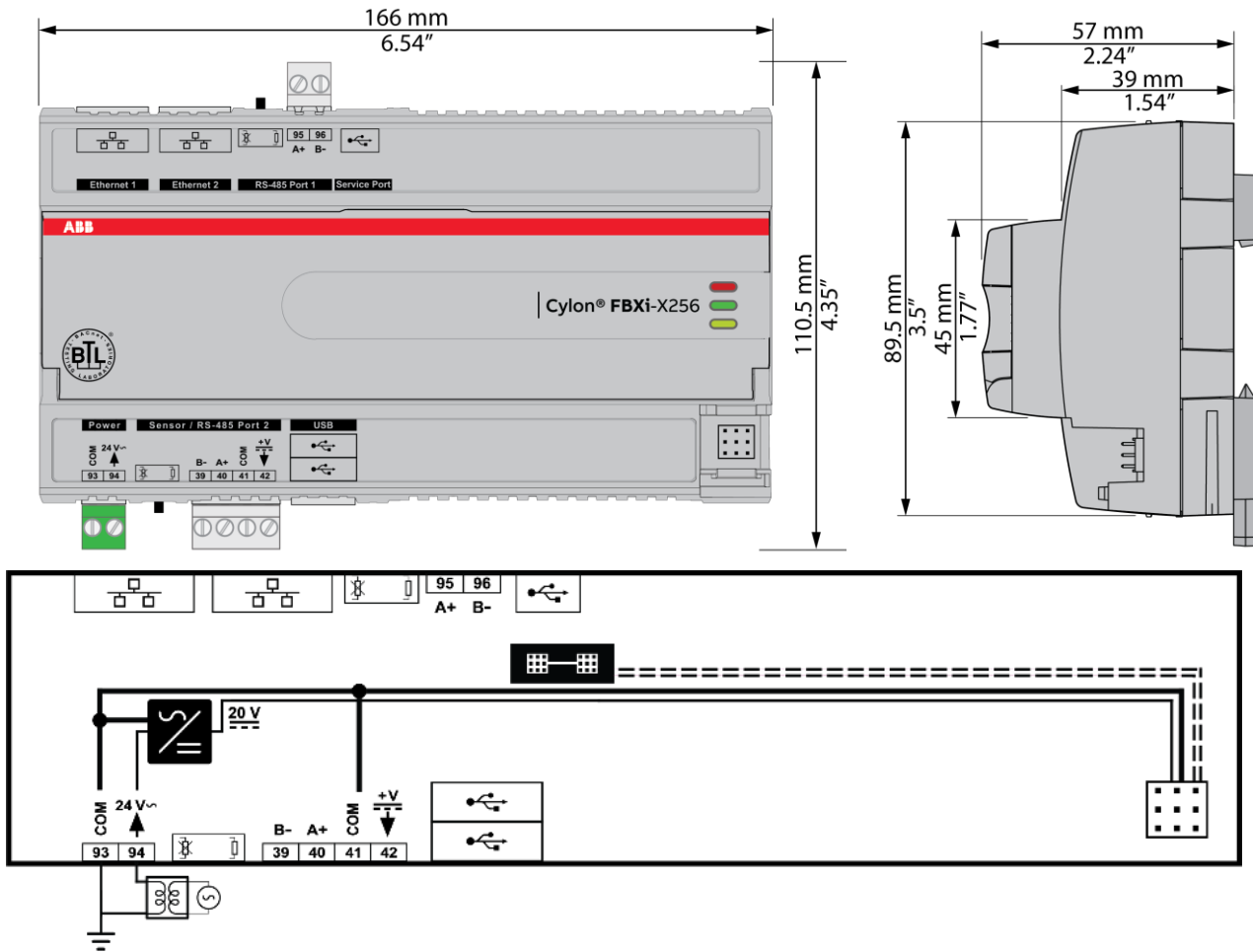

## 6 FBXi Operation





### PHYSICAL LAYOUT





**CAUTION** - DANGER OF EXPLOSION IF BATTERY IS INCORRECTLY REPLACED. REPLACE ONLY WITH THE SAME OR EQUIVALENT TYPE RECOMMENDED BY THE MANUFACTURER. DISPOSE OF USED BATTERIES ACCORDING TO THE MANUFACTURER'S INSTRUCTIONS.

Supply Requirements	24 V AC $\pm 20\%$ 50/60 Hz
Supply Rating	FBXi 20 VA (no FLX modules)
	FBXi + 1 x FLX 32 VA
	FBXi + 2 x FLX 44 VA
	56 VA
	FBXi + 16 x FLX 68 VA
FLX Power Connection	Proprietary FLX bus connector carries power and comms from FBXi unit. FBXi-X256 can supply power to up to 4 FLX modules.

	Terminal Numbers	Description
	93, 94	<p>Power 24 V AC</p> <p><b>Important:</b> The common power connection (terminal 33) must be connected to Earth. ABB Cylon recommend that this is done at the 24 V AC transformer.</p>
	95, 96	<p>RS-485 Port 1 (BACnet® MS/TP) screw terminal</p> <p>MS/TP subnet terminator switch is located beside the port. If the switch is towards the  icon, then termination is <i>in</i> and if the switch is towards the  icon then termination is <i>out</i>.</p>
	39 ... 42	<p>Sensor / RS-485 Port 2 (CBT-STAT / Modbus)</p> <p>The bus Terminator Switch is located beside the port. If the switch is towards the  icon, then termination is <i>in</i> and if the switch is towards the  icon then termination is <i>out</i>.</p>

	Description
	Ethernet Ports
	<p>USB ports</p> <p>Used for firmware upgrade</p>
	<p>Indicator LEDs</p> <p>(See <i>FBXi Indicator LED Signals</i> on page 71)</p>
	<p>Push buttons and Signal LEDs</p> <p>(See <i>Restarting, Resetting and upgrading the FBXi</i> on page 78)</p>
	<p>Inter-module connection sockets</p> <p>To join the FLX bus, place the devices side-by-side and place the <b>FLX bus connector</b> into the two adjacent sockets at once.</p> <p>The end device on a <b>FLX bus</b> (either a <b>FLX</b> device or the <b>FBXi</b> itself) must have a terminator inserted into its interconnector socket. One terminator is shipped with each <b>FBXi</b> device.</p>

### FBXi INDICATOR LED SIGNALS

	Off	On	Slow Blink	Fast blink
	Power is off	Power is on	— Unit Rebooting —	
	Unit is not running	Strategy Loaded but no network connectivity	Strategy Loaded and device communicating on network	No Strategy loaded
	FLX bus comms are ok	No FLX bus comms	FLX bus address clash	FLX bus comms error

During firmware upgrade over IP network, the Yellow LED will remain on while the strategy/comms section reboots, and then the LEDs will rotate Red-Green-Yellow while the IO section reboots.

**Note:** During typical operation, the Red LED should be on, the Green LED should be blinking and the Yellow LED should be off.



## INPUTS AND OUTPUTS – FLX MODULES

FLX-8R8 and FLX-8R8-H have identical I/O capabilities – each has a set of 8 Universal Inputs and a set of 8 UniPuts™ with relay.

FLX-4R4 and FLX-4R4-H have 4 Universal Inputs and 4 UniPuts with relay.

FLX-16DI has 16 Digital Inputs only.

Any of the terminals can be configured as inputs. Any of the UniPut terminals can be configured as an output.

### INPUT MODES

Universal Input terminals and UniPut™ terminals can be configured as inputs in almost identical fashion:

Measurement Mode	Universal Input	UniPut™ as Input:	Digital Input
Resistance	<b>Resistance measurement</b> Range: 0 ... 450 kΩ Accuracy: ±0.5% of measured resistance		-
	<b>Temperature measurement</b> Range: -40 °C ... +110 °C Accuracy: 10k NTC sensors (e.g. 10k Type 2 (10K3A1) or 10k Type 3 (10K4A1): ±0.3 °C, -40 to 90 °C (-40°F to 194°F); ±0.4 °C > 90 °C (194°F)		-
	Digital Volt-Free contact, 2 mA contact-wetting current		
	<b>Pulse counting (volt-free)</b> up to 20 Hz, 25 ms – 25 ms		-
	-	24 V AC Detect	-
Voltage	<b>Analog Input</b> Range: 0 ... 10 V @ 130 kΩ Accuracy: ±0.5% full scale [50mV]	<b>Analog Input</b> Range: 0 ... 10 V @ 40 kΩ Accuracy: ±0.5% full scale [50mV]	-
	Pulse counting (0 ... 10 V) up to 20 Hz, 25 ms – 25 ms		-
Current	<b>Current input</b> Range: 0 ... 20 mA @ 390 Ω Accuracy: ±0.5% full scale [100µA]	<b>Current input</b> Range: 0 ... 20 mA @ 390 Ω  Note: Current Input requires user-supplied external 390 Ω resistance.  Accuracy: depends on user supplied external resistor	-

**Note:** Inputs use on-board 16-bit analog to digital convertor.

**Note:** All inputs and outputs are protected against short circuit, as well as over-voltage up to 24 V AC.

Hardware point numbers for these inputs in the FBXi-X256's strategy:

	FLX address 1	FLX address 2	---	FLX address 15	FLX address 16
Inputs	101 ... 108	201 ... 208	---	401 ... 408	501 ... 508
Outputs	109 ... 116	209 ... 216	---	409 ... 416	509 ... 516



### Resistance Input mode (Passive Input)

Passive Inputs are all those devices that vary in resistance, including switch contacts.

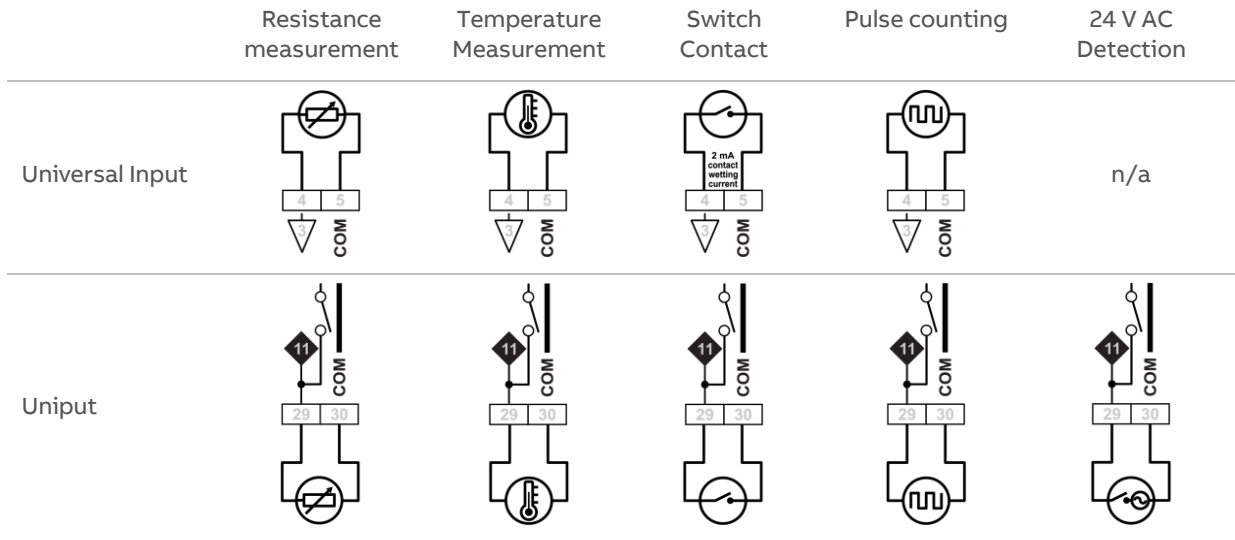

These all require a current supplied by the FLX terminal so that this resistance can be measured.

The passive sensor types supported by the FBXi-X256 are:

- Pre-programmed Passive Temperature Sensors.
- Potentiometer (normally used as a 0 to 10 KΩ or a 1 KΩ to 11 KΩ variable resistor to give a 0 to 100 % output).
- Volt-Free Digital Input (the controller strategy measures the contact resistance and gives a 0 or 1 output).
- Straightforward Resistance measurement. This can be used with the **Make Linear** block to give a temperature output for temperature sensors that are not factory pre-programmed into the FBXi-X256.

In CXpro<sup>HD</sup> simply select 'Resistance' sensor type in the Point Module and select Pulsed in the Advanced parameters (the Pulsed option increases accuracy by eliminating any self-heating in the passive temperature sensor, while the Continuous option can trade absolute accuracy for speed).

In Passive Input Mode the Uninputs™ and Universal Inputs configure like this:

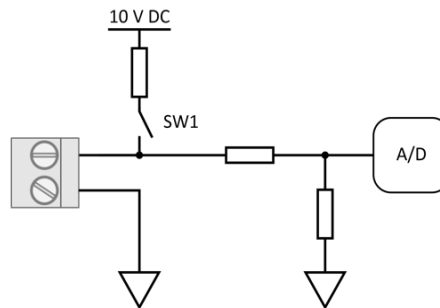

**Note:** The reference voltage can be pulsed or continuous, using the solid state switch. A pulsed reference gives optimum accuracy by eliminating self-heating in the sensor, and this is the default setting.

### UniPut™ 24 V AC Detection

If 24 V AC is connected to a Uninput™ terminal, then the 24 V AC Detect circuit will detect this and will open switch SW1. SW1 stays open for the duration of the 24 V AC state. When 24 V AC is removed from the Uninput™ terminal then the short circuit or open circuit states can again be detected.

### Voltage input mode (Active Input)

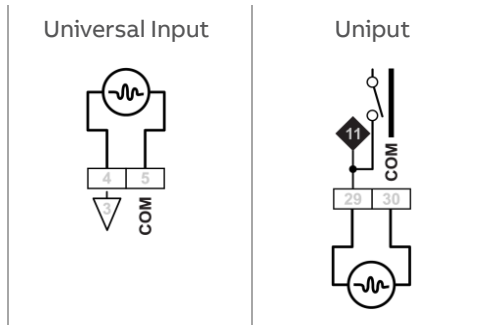

**Note:** Input Impedance for Universal Input terminals is 130 kΩ.  
Input Impedance for Uninput™ terminals is 40 kΩ.

The 0 ... 10 V input is used for Active analog and digital measurements. 'Active' means that there is no current supplied by the FLX for the sensor, as the signal is generated completely by the Sensor.

The 'mV' sensor setting gives a value between 0 and 10,000, which represents voltage in mV.

In 0 ... 10V Input Mode, the Uninputs™ configure like this:

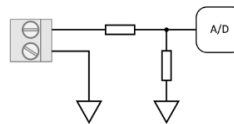

### Current Input mode (Active Input)

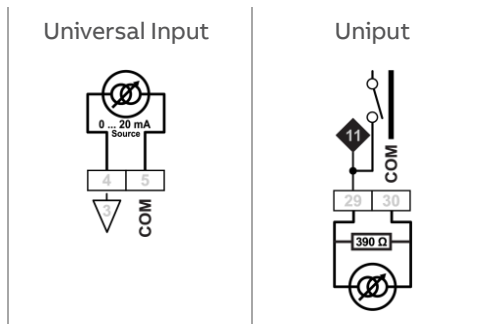

The Current Input is used for 0 ... 20 mA or 4 ... 20 mA Active sensors.

4 ... 20 mA scaling can easily be achieved using CXpro<sup>HD</sup> by entering range values in the Point Module 'Advanced' parameters.

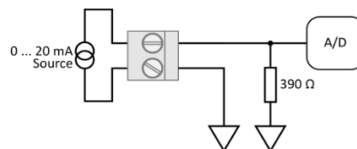

## OUTPUT MODES

UniPut terminals can generate an output as follows:

- Analog Output 0 ... 10 V, 20 mA, 12-bit resolution
- Digital Output 0 ... 10 V, 20 mA
- Relay Contacts with ability to switch up to 24 V AC  
Maximum Load: 24 V AC, 2 (1) A resistive (inductive) for all relay contacts

### Analog 0 ... 10 V output mode

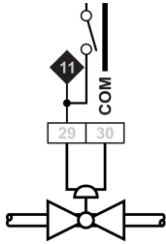

In Analog 0 ... 10 V output Mode, the Uniputs configure themselves like this:  
where the D/A is the digital to analog converter. All circuitry is fully protected against 24 V AC.

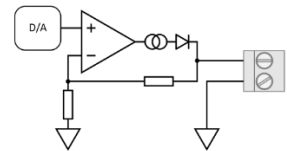

### Digital 0 ... 10 V output mode

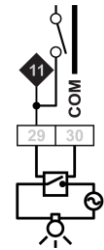

In Digital 0 ... 10 V output Mode, the Uniputs configure in the same way as for analog:

In this mode the output toggles between the voltages defined as “ON” and “OFF”.

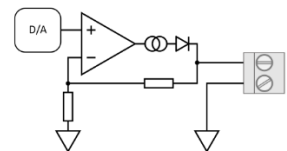

### Relay Mode

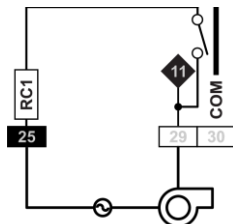

In Relay mode the Uniputs are configured with a single relay common for each half of the terminals:

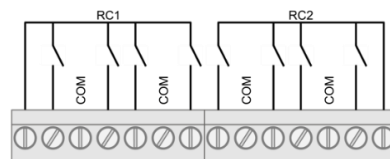

## AUXILIARY POWER OUTPUTS

FLX modules each have two 18 V DC outputs, for I/O devices that require loop power.

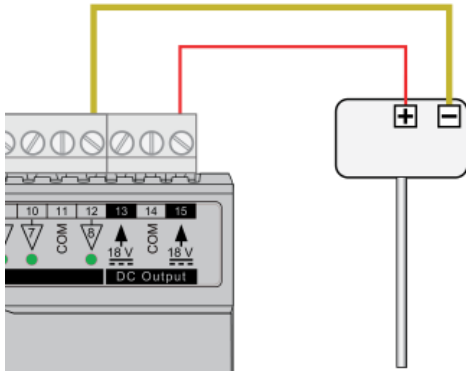

For 3-wire connections return can be through any COM terminal, but it is recommended that Auxiliary power wiring is through terminal 14, the COM between the two Auxiliary power terminals.

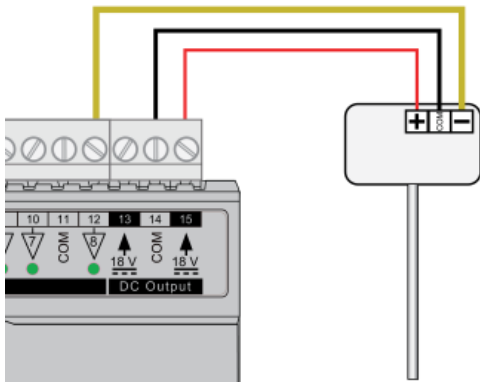

The DC output terminals provide a minimum of 18 V DC, but the combined load (on each IO module) must remain below 60 mA.

## USING A KEYPAD WITH THE FBXi

A CBT-STAT or UCU Room Display keypad can be connected to the CBX at the CBT-STAT port.



**Note:** If UCU Room Display is used, refer to the *DS0064 UCU10FC/K* for the corresponding Strategy Point Setup.

The Controller Strategy can determine if an override is in place by connecting to the **Override** point on the output module:

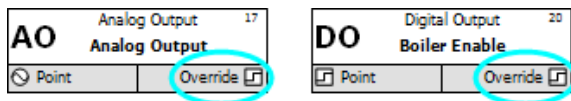

The value of the **Override** point will be '0' when the output is active and '1' when the point has been manually overridden. This allows the strategy to react to the fact that a point has been overridden.

**Note:** The corresponding terminal LED will indicate the override condition.

## RESTARTING, RESETTING AND UPGRADING THE FBXi

The FBXi controller can be restarted or reset using the two buttons located on the front panel (under the flap) marked SW1 and SW2. Beside these buttons there are two LEDs marked L1 and L2, which are used to signal the progress of the reset or upgrade:

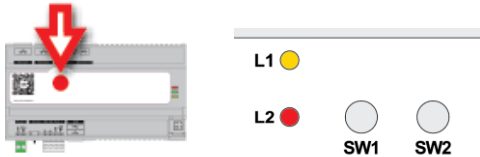

### RESETTING THE WEBUI LOGIN

If the WebUI username / password or IP address have been changed to unknown values so that you cannot log in to the WebUI, you can reset them to known values, i.e. the Factory defaults:

- username: `admin`
- password: `cylonct1`
- IP address: based on serial number (see *Configuring the IP connection* on page 39)

To reset the IP address and password, press SW1 while the controller is running, hold it until LED L2 lights up, and then release SW1.

### FULL FACTORY RESET

To restore all settings in the FBXi, including any strategy configuration, the shipped version of firmware, controller IP address and the WebUI username / password : press SW1 while the controller is booting, hold it until the LED lights up, and then release SW1.

During Factory reset, LED L2 will indicate the progress as follows:

- Slow blink: Reset in progress
- Solid colour: Reset successful. Power-cycle the controller to activate.
- Fast blink: Reset failed

### UPGRADE FIRMWARE FROM USB

insert a FAT-formatted USB drive containing valid firmware (.swu) into either of the USB ports, while the controller is booting hold SW1 until LED L1 lights up, then release SW1.

During USB upgrade, LED L1 will indicate the progress as follows:

- Slow blink: Upgrade in progress
- Solid colour: Upgrade successful. Power-cycle the controller to activate.
- Fast blink: Upgrade failed

### RESTARTING THE CONTROLLER WITHOUT POWER CYCLING

To restart the FBXi without disconnecting the power, press SW2 while the controller is running, hold it until LED L2 lights up, and then release SW2





---

ABB CYLON CONTROLS

Clonshaugh Business &  
Technology Park  
Clonshaugh  
Dublin 17  
Ireland

Tel.: +353 1 245 0500  
Fax: +353 1 245 0501  
Email: [info@cylon.com](mailto:info@cylon.com)

---

ABB CYLON CONTROLS

ONE TECHNOLOGY LANE  
EXPORT,  
PA 15632

Tel.: +1 724 733-2000  
Fax: +1 724 327-6124